

PARTS LIST:

1	Driver/left side NB1 Running Board	32	10mm x 27mm x 3mm Flat Washers
1	Passenger/right side NB1 Running Board	16	10mm Nylon Lock Nuts
4	Driver/left side Mounting Brackets	16	8-1.25mm x 30mm Hex Bolts
4	Passenger/right side Mounting Brackets	16	8mm Lock Washers
16	10-1.5mm x 35mm Hex Bolts	16	8mm x 24mm x 2mm Flat Washers

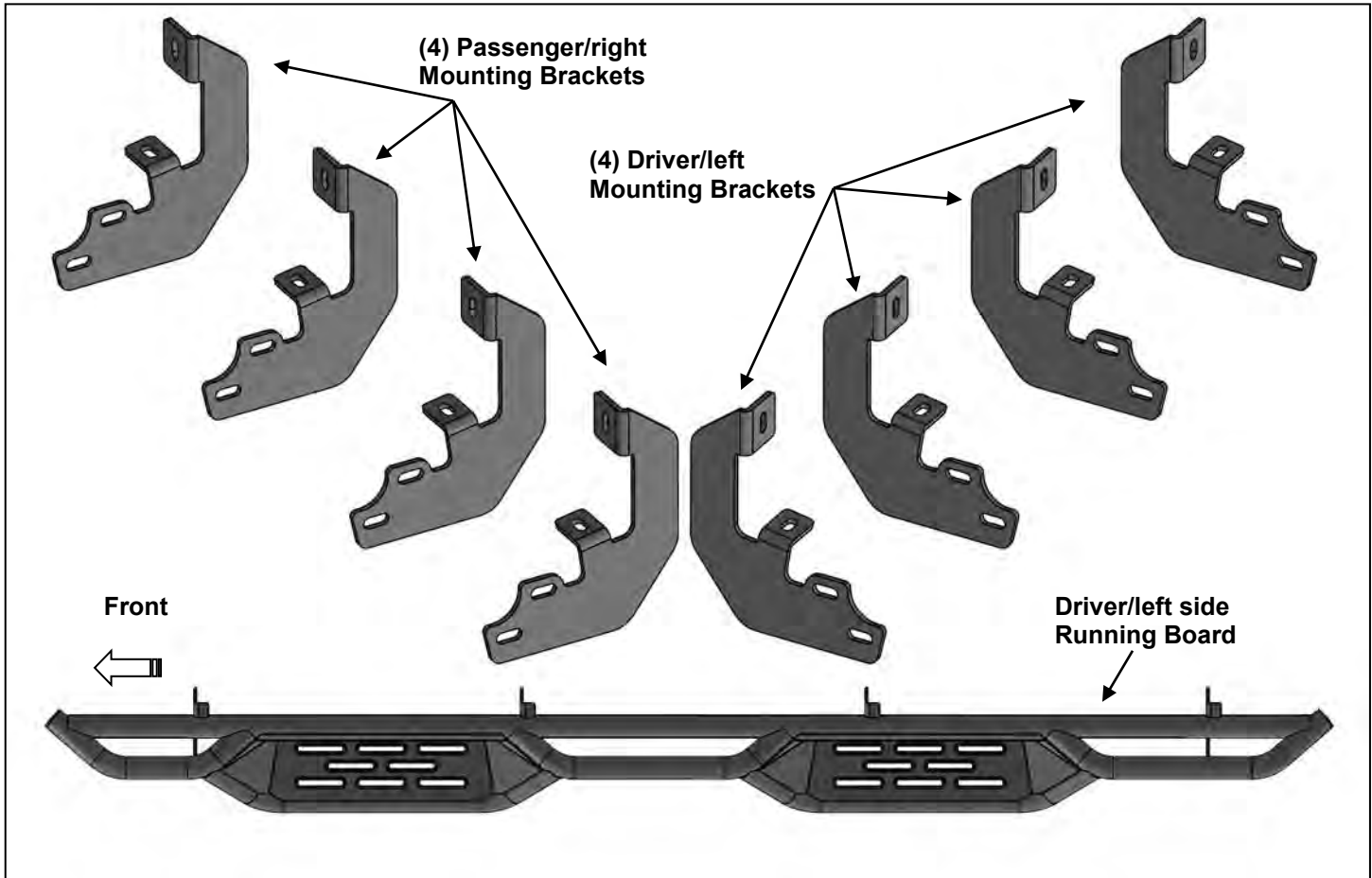

PROCEDURE:

REMOVE CONTENTS FROM BOX. VERIFY ALL PARTS ARE PRESENT. READ INSTRUCTIONS CAREFULLY BEFORE STARTING INSTALLATION. ASSISTANCE IS RECOMMENDED.

1. Start the installation under the driver side of the vehicle. Locate the 6 plugs along the bottom edge of the body. Mounting Brackets will bolt to the 1st, 3rd, 4th and 6th threaded mounting holes, **(Figures 1—6)**. Remove the plastic plugs from each mounting location. Directly above each threaded insert is a top mounting location on the side of the body panel. Hold a Bracket up in place to help determine the correct mounting holes to use along the body. **NOTE:** Thread an 8mm Hex Bolt into the threaded inserts to clear paint as required.
2. Select (1) Driver/left side Mounting Bracket. Starting at the front of the driver/left side, bolt the Mounting Bracket to the factory threaded holes with (2) 8mm Hex Bolts, (2) 8mm Lock Washers and (2) 8mm Flat Washers, **(Figures 7 & 8)**. Do not tighten hardware at this time.
3. Repeat **Steps 1 & 2** to install (3) Driver/left side Mounting Brackets on the remaining mounting locations along the body panel, **(Figures 9 & 10)**.
4. Carefully unwrap and select the Driver/left side Running Board. Use the illustration above to help identify the correct Running Board. Position the mounting tabs on the Running Board to the rear side of the Mounting Brackets, **(Figure 11)**.
5. Attach the Running Board to the Brackets using (8) 10mm Hex Bolts, (16) 10mm Flat Washers and (8) 10mm Nylon Lock Nuts, **(Figures 11—15)**. Do not tighten hardware at this time.
6. Level and adjust the Running Board as necessary and fully tighten all hardware.

7. Repeat **Steps 1—6** for Passenger/right side Running Board installation.
8. Do periodic inspections to the installation to make sure that all hardware is secure and tight.

To protect your investment, wax this product after installing. Regular waxing is recommended to add a protective layer over the finish. Do not use any type of polish or wax that may contain abrasives that could damage the finish. Aluminum polish may be used to polish small scratches and scuffs on the finish. Mild soap may be used also to clean the Running Board.

Driver/left side Installation Pictured

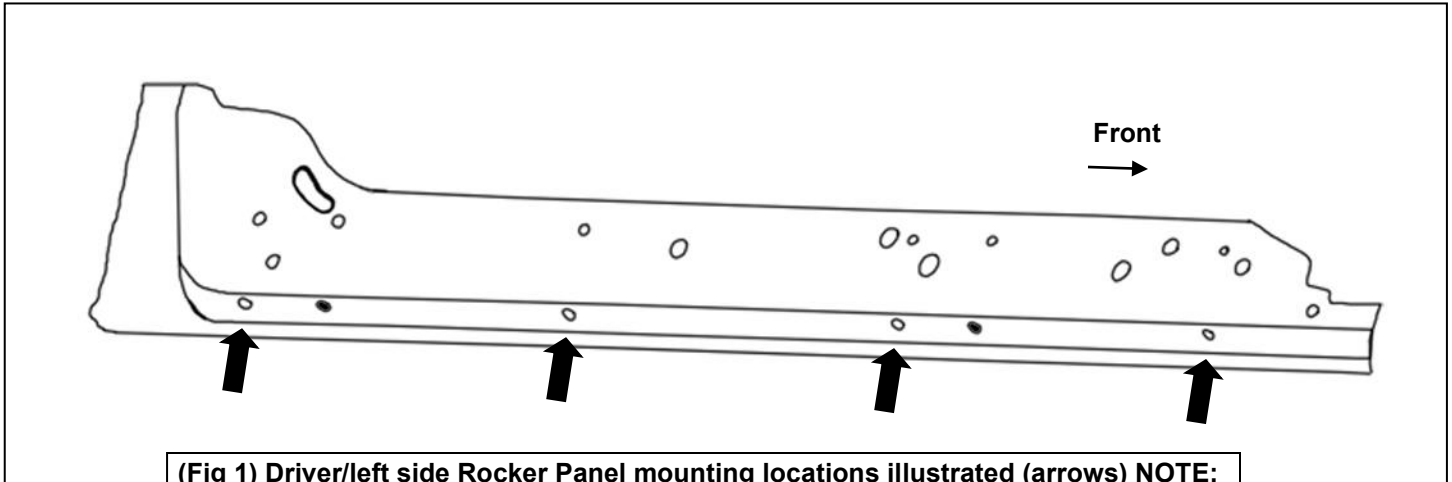

(Fig 1) Driver/left side Rocker Panel mounting locations illustrated (arrows) NOTE: Hold Bracket up to body panel to help determine the correct mounting locations.

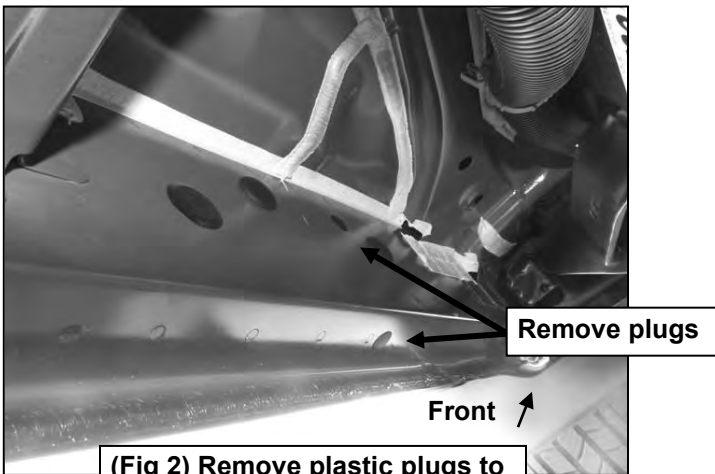

(Fig 2) Remove plastic plugs to uncover threaded inserts

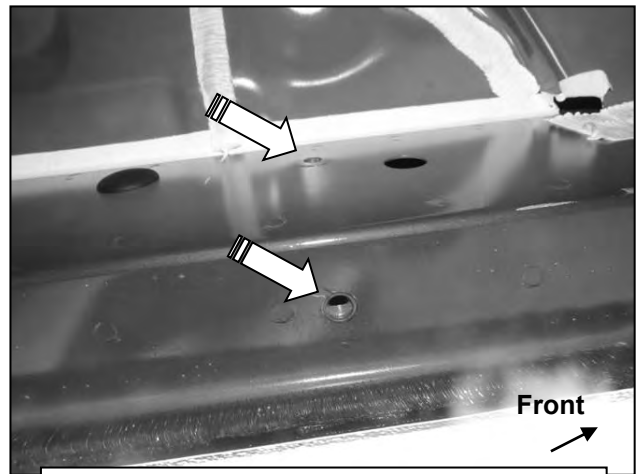

(Fig 3) Driver side front mounting location

Driver/left side Installation Pictured

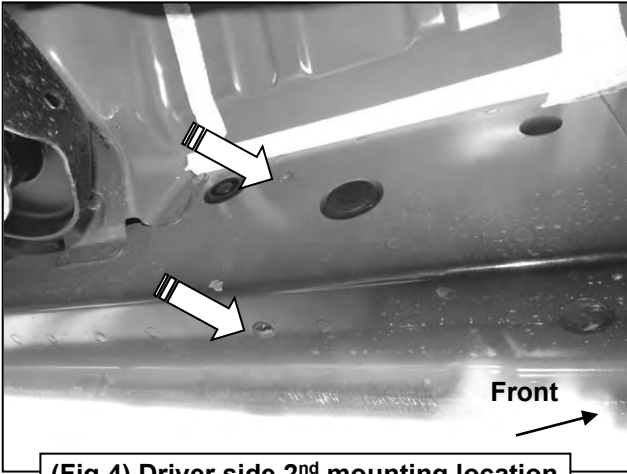

(Fig 4) Driver side 2nd mounting location

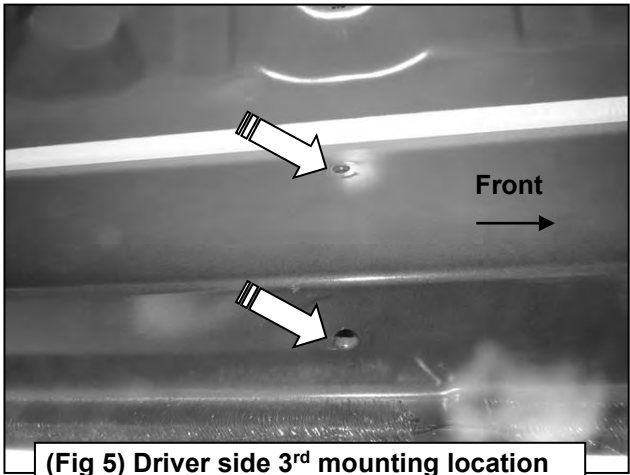

(Fig 5) Driver side 3rd mounting location

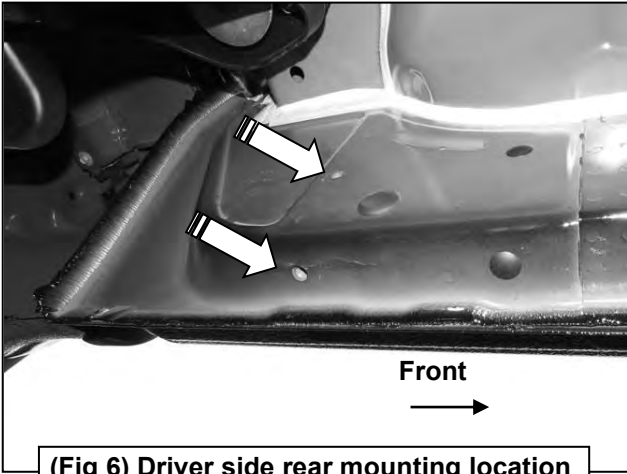

(Fig 6) Driver side rear mounting location

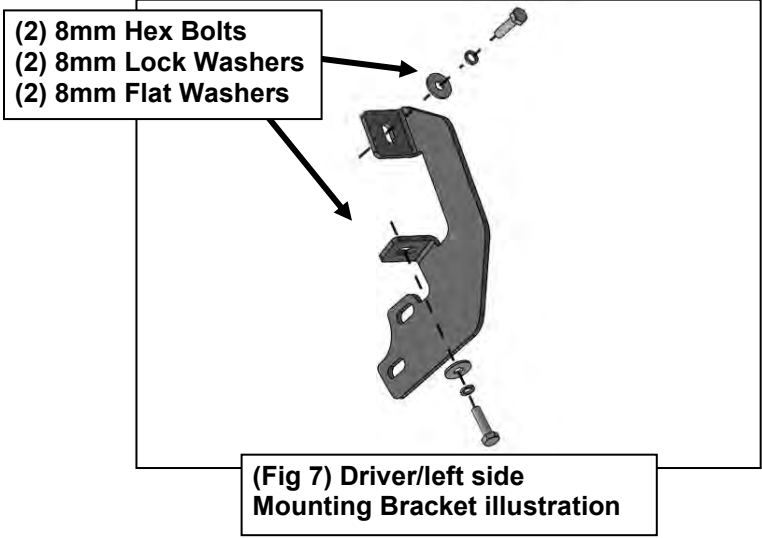

(Fig 7) Driver/left side
Mounting Bracket illustration

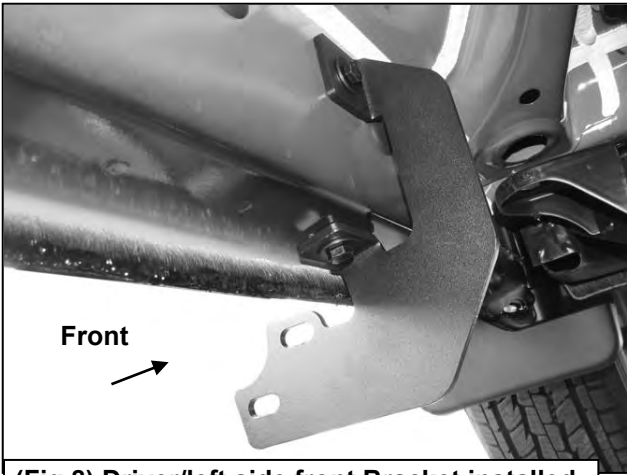

(Fig 8) Driver/left side front Bracket installed

Driver/left side Installation Pictured

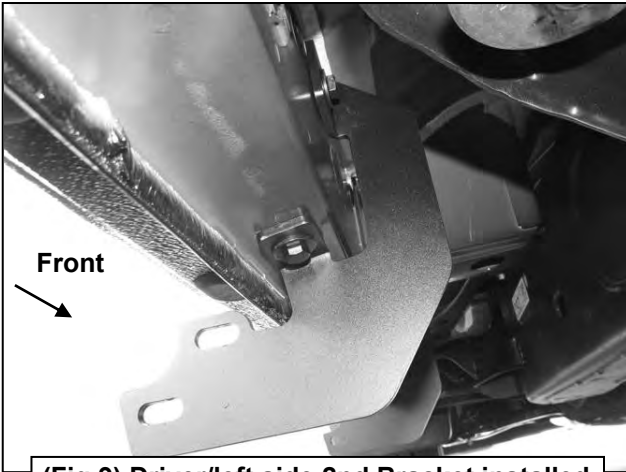

(Fig 9) Driver/left side 2nd Bracket installed



(Fig 10) Driver/left side rear Bracket installed

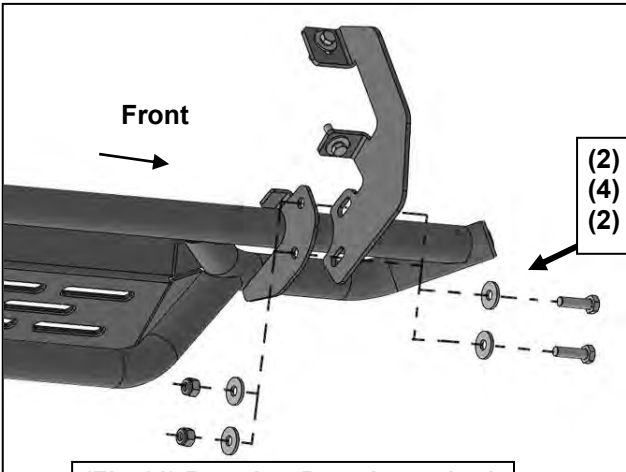

(Fig 11) Running Board attached to Bracket illustrated

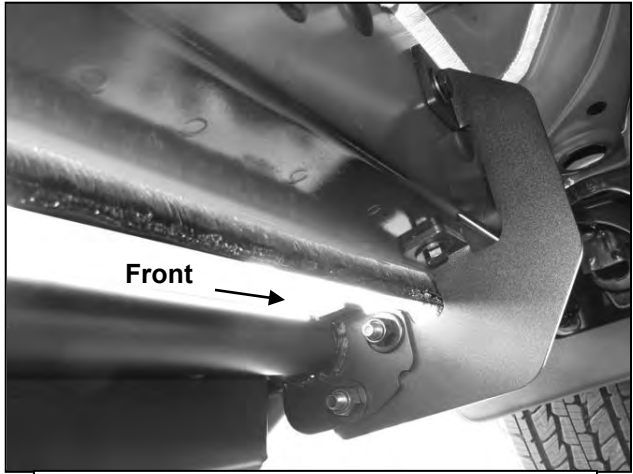

(Fig 12) Driver side front Complete install

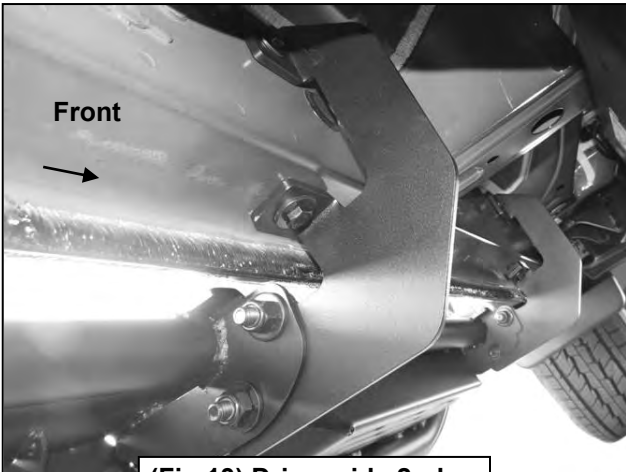

(Fig 13) Driver side 2nd location complete install

Driver/left side Installation Pictured

