

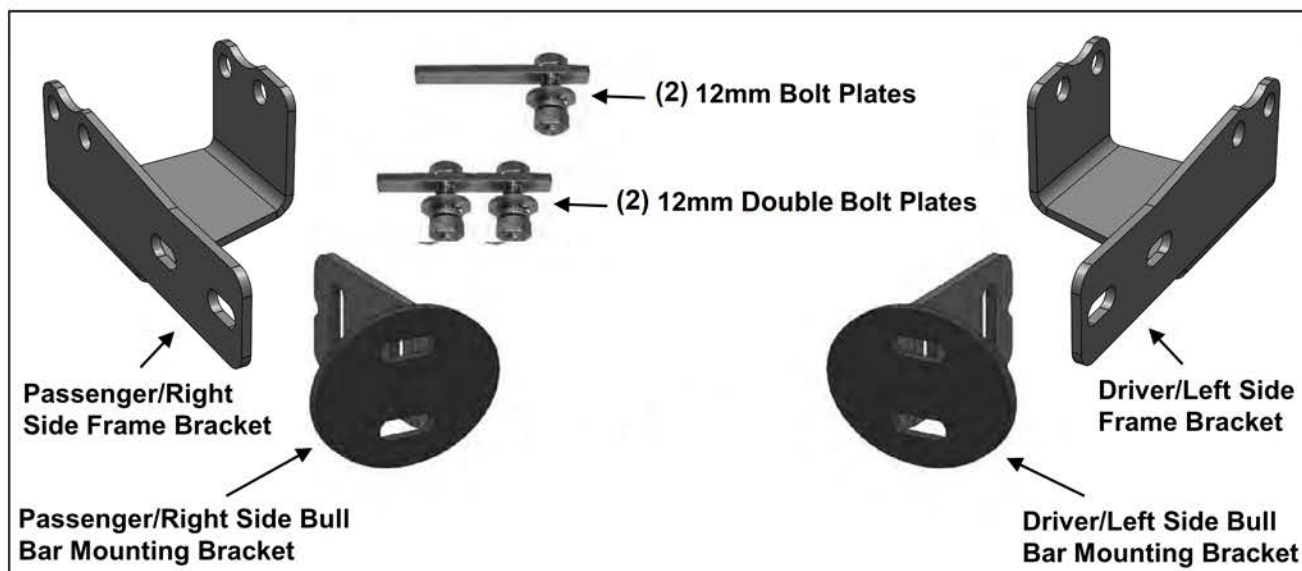

2007-18 SILVERADO/SIERRA 1500 OCTA BULL BAR

Qty	Description	Qty	Description
1	OCTA Bull Bar - Stainless Steel	4	10-1.50mm x 35mm Hex Bolts
1	Driver side Frame Bracket	8	10mm x 27mm OD x 3mm Flat Washers
1	Passenger Side Frame Bracket	4	10-1.50mm Nylon Lock Nuts
2	Bull Bar Mounting Brackets	4	8-1.25mm x 35mm Hex Bolts
2	12mm x 35mm Bolt Plates	4	8mm x 22mm OD x 2mm Flat Washers
2	12mm x 30mm Bolt Plates	4	8mm Lock Washers
6	12mm x 24mm OD x 3mm Flat Washer		
6	12-1.75mm Nylon Lock Nuts		



PROCEDURE:

REMOVE CONTENTS FROM BOX. VERIFY ALL PARTS ARE PRESENT. READ INSTRUCTIONS CAREFULLY BEFORE STARTING INSTALLATION. CUTTING MAY BE REQUIRED. ASSISTANCE IS RECOMMENDED. NOTE: It may be necessary to remove/relocate the front license plate and license plate bracket.

- Start installation from under the front of the vehicle. Determine if the vehicle is equipped with tow hooks.
IMPORTANT: Tow hooks cannot be reinstalled with the Bull Bar.
Tow Hook equipped vehicles:
Remove the factory tow hook from the end of each frame channel, (Figure 1). Skip to **Step 2** if tow hooks were accessible and have been removed. **NOTE:** Tow hooks on 2014-on models may be difficult to remove and assistance is highly recommended on these models. The following info only applies to the 2014-on models.
 - On models with factory fog lights, unplug both lights. Move all wiring harnesses away from bumper.
 - Open the hood and remove the cover between the top of the radiator and the grille. Remove the bolts attaching the bottom of the grille if attached to the cross member. Remove the grille.
 - On 2014-15 models, from behind the bumper, release the clips and hardware to remove the plastic body panel, (facia), on top of the bumper between the bottom of the grille and the top of the bumper, (Figure 2).
 - Remove the outer bumper supports on each side of the frame.

- e. Place blocks or jack stands under the front bumper to support it during mounting bolt removal. Once the bumper has been safely supported, remove the factory bumper bolts attaching the bumper to the inner bumper bracket bolted to the end of the frame, **(Figures 2 & 3)**. **WARNING!** Assistance is required to hold the bumper in place during bolt removal to prevent the bumper from falling. Carefully slide the bumper assembly with brackets off of the ends of the frame.
- f. Once bumper has been removed, remove both tow hooks.
- g. Reattach the bumper, fascia panel if equipped and grille after both tow hooks have been removed and the openings have been checked for Bracket clearance. Trim around openings as required for Bracket clearance.
- h. Tighten all factory bumper hardware at this time.
- i. Proceed to **Step 2**.

Vehicles without tow hooks:

- a. Cut out the indented area in both sides of the plastic bumper insert to clear the Brackets as pictured, **(Figures 4 & 5)**. **IMPORTANT:** Make several small cuts for best fit. Do not cut through the top edge of the panel. **NOTE:** On 2014-15 models, the plastic panel is held in place with several small screws. The screws at the top corners are difficult to impossible to reach and remove without damaging the cover with the bumper in place. If you prefer to remove the panel to cut out the openings, it will be easier to remove the bumper assembly with the plastic panel attached.
 - b. Reattach the bumper assembly, (if removed), fascia and grille once openings have been cut out and checked for clearance. Tighten all factory bumper hardware at this time.
2. Select the driver side Mounting Bracket. Insert the Bracket through the opening in the bumper, **(Figure 5)**. Trim the plastic as required to clear the Brackets.
 3. Line up the holes in the Bracket with the holes in the end of the frame channel for the tow hook, **(Figure 6)**. Select (1) 12mm Double Bolt Plate, **(Figure 7)**. Insert the Bolt Plate into the end of the frame, through the (2) holes in the side of the frame and out through the Bracket, **(Figures 8 & 9)**. Secure the Bracket to the Bolt Plate with (2) 12mm Flat Washers and (2) 12mm Nylon Lock Nuts. Snug but do not fully tighten hardware at this time.
 4. Repeat **Step 3** to install the 12mm x 35mm Single Bolt Plate, **(Figure 10)**, into the remaining hole in the other side of the frame channel and Bracket, **(Figures 11 & 12)**.
 5. Repeat **Steps 2—4** to install the passenger side Mounting Bracket.
With assistance, hold the Bull Bar up in position on the outside of the Mounting Brackets. Bolt the Bull Bar to the Brackets with (4) 10mm x 30mm Hex Bolts, (8) 10mm Flat Washers and (4) 10mm Nylon Lock Nuts, **(Figure 13)**. Do not tighten hardware at this time.
 6. Check the Bull Bar alignment with the vehicle and for clearance between the Bull Bar and the bumper.
 7. Adjust as required then fully tighten all hardware at this time.

INSTALLATION COMPLETE

To protect your investment, wax this product after installing. Regular waxing is recommended to add a protective layer over the finish. Do not use any type of polish or wax that may contain abrasives that could damage the finish.

For stainless steel: Aluminum polish may be used to polish small scratches and scuffs on the finish. Mild soap may be used also to clean the Bull Bar.

For black finishes: Mild soap may be used to clean the Bull Bar.

Driver Side Mounting Bracket Installation Pictured

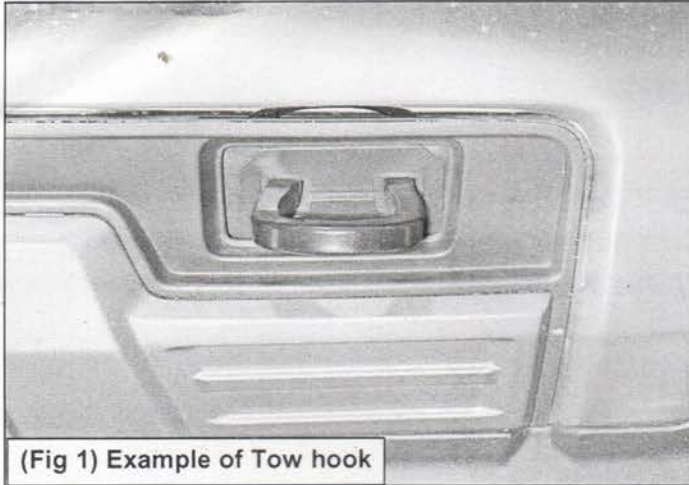

(Fig 1) Example of Tow hook

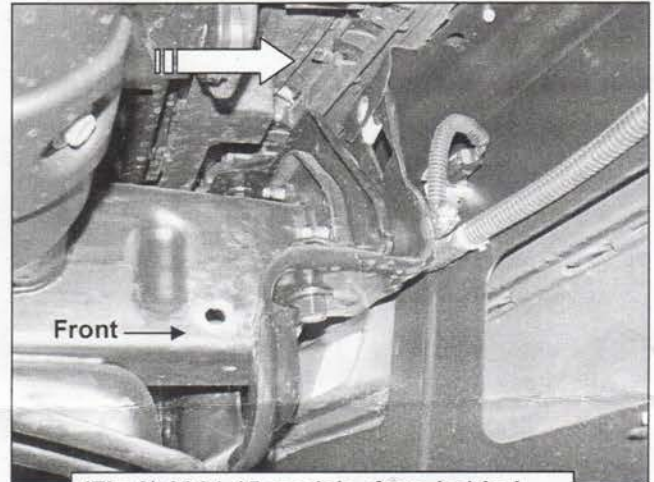

(Fig 2) 2014-15 models, from behind the bumper, remove the clips securing the fascia to the top of the bumper

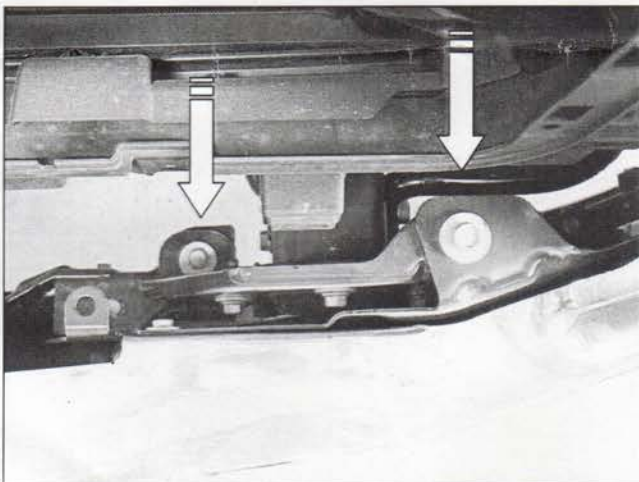

(Fig 3) 2016 model to show bumper bolt locations from above (arrows) with grille removed. 2014-15 models also remove plastic fascia panel to access bumper bolts as necessary

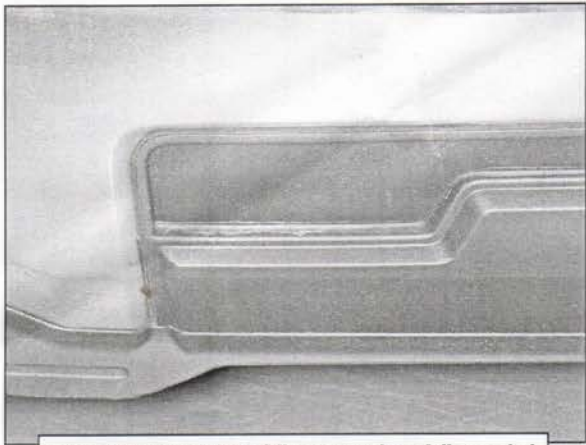

(Fig 4) Example of "no tow hook" model

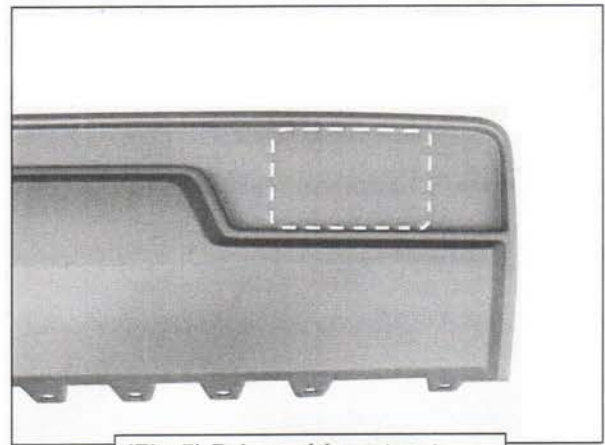

(Fig 5) Driver side cut out illustrated for reference only

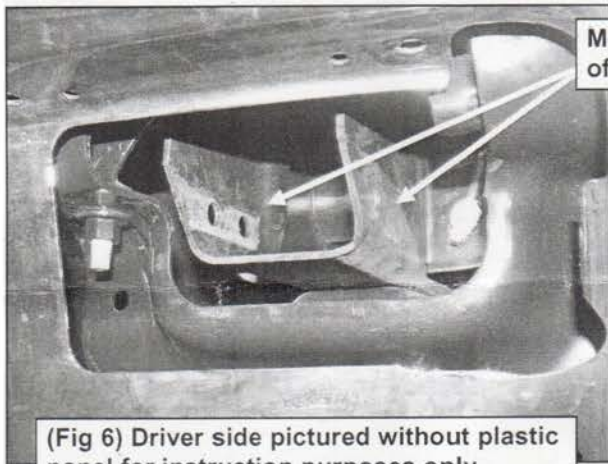

Mounting holes in end of frame for tow hook

(Fig 6) Driver side pictured without plastic panel for instruction purposes only

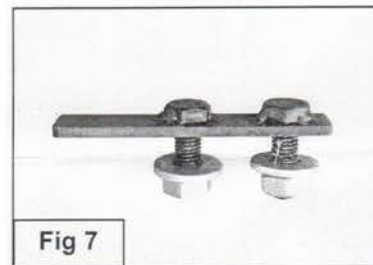
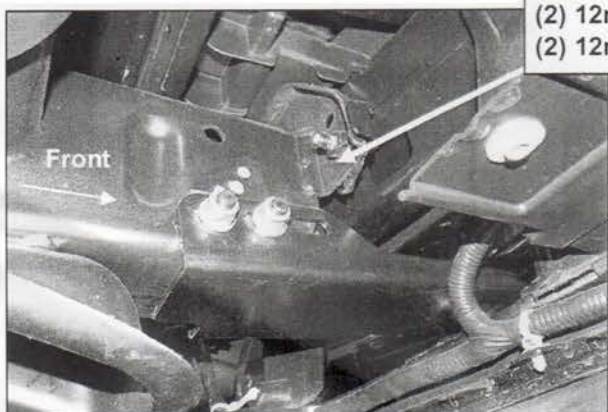

Fig 7



12mm Double Bolt Plate
(2) 12mm Flat Washers
(2) 12mm Nylon Lock Nuts

(Fig 8)



(Fig 9) Inner driver side Bracket with Double Bolt Plate

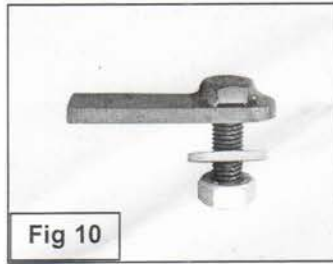

12mm Single Bolt Plate
12mm Flat Washer
12mm Nylon Lock Nut

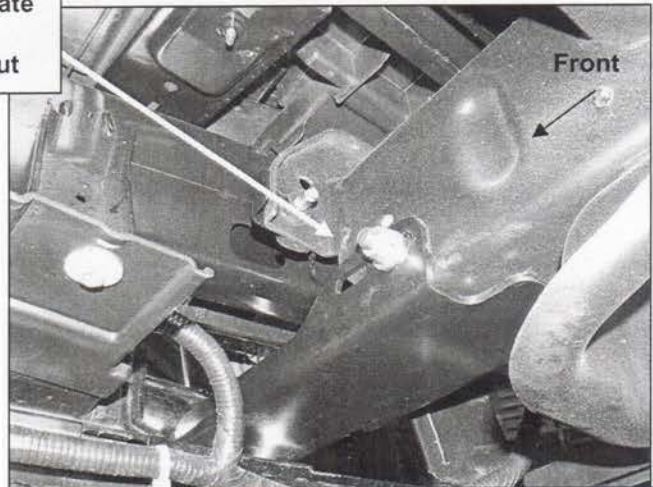

(Fig 11) Passenger Bracket installed in "forward" position to move Bull Bar away from bumper

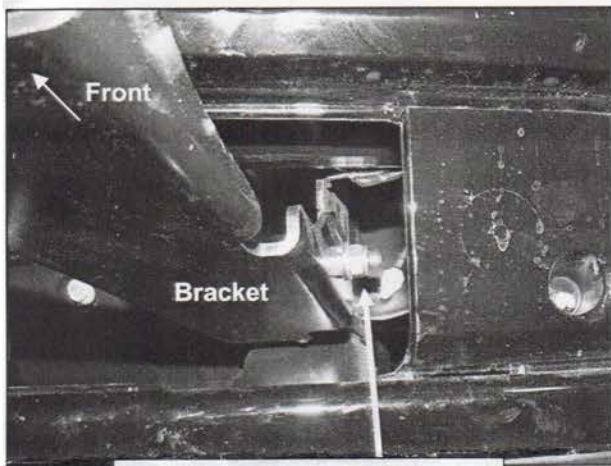

(Fig 12) Outer driver side Bracket with Single Bolt Plate

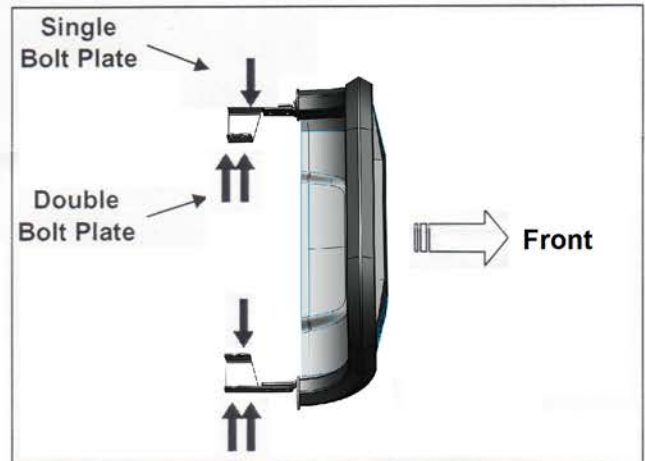

(Fig 13) Typical Silverado/Sierra mounting position



COMPLETE INSTALLATION