

PARTS LIST:

1	Driver/Left Sidebar	16	8-1.25mm x 30mm Hex Bolts
1	Passenger/Right Sidebar	8	8-1.25mm x 25mm Hex Bolts
2	Driver/Left Mounting Brackets	32	8mm ID x 24mm OD x 2mm Flat Washers
2	Passenger/Right Mounting Brackets	24	8mm Lock Washers
8	8mm Clip Nuts	8	8mm Hex Nuts

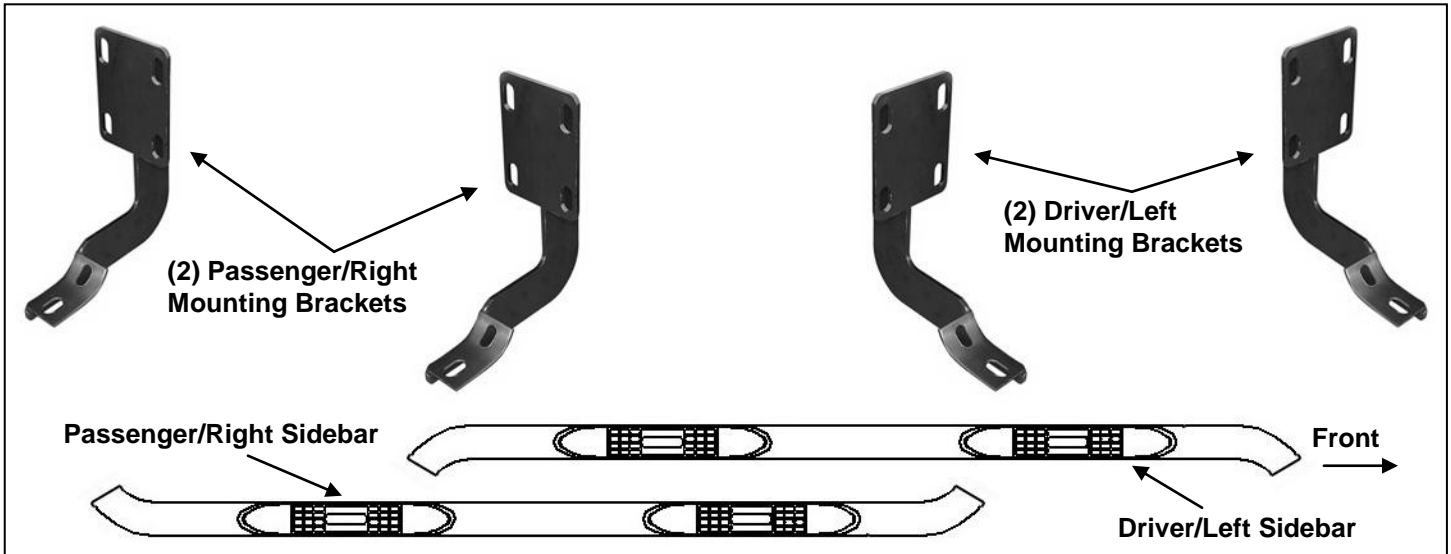

PROCEDURE:

- 1. REMOVE CONTENTS FROM BOX. VERIFY ALL PARTS ARE PRESENT. READ INSTRUCTIONS CAREFULLY BEFORE STARTING INSTALLATION.**
- Starting on the driver side-front of the vehicle, locate the 2nd set of factory holes in the body panel and pinch weld directly under the center of the front door, **(Figure 1)**. Each mounting location is comprised of a rectangular hole with a round hole on each side and two holes in pinch weld, **(Figures 2 & 3)**.
- Select (2) 8mm Clip Nuts. Insert the Clip Nuts one at a time into the rectangular opening and slide the threaded hole outward towards the round hole. Line up the threaded hole in the Clip with the round hole. **NOTE:** Threaded nut must go towards the inside of the side panel, **(Figures 2 & 3)**.
- Partially attach the driver side front Mounting Bracket to the Clip Nuts using the included (2) 8mm x 30mm Hex Bolts, (2) 8mm Lock Washers and (2) 8mm Flat Washers, **(Figure 4)**. **NOTE:** Cradles on the Mounting Brackets should face the front of the vehicle.
- Bolt the (2) bottom holes in the Mounting Bracket to the (2) holes in the pinch weld using the included (2) 8mm x 30mm Hex Bolts, (2) 8mm Lock Washers, (4) 8mm Flat Washers and (2) 8mm Hex Nuts, **(Figure 4)**. Do not tighten hardware at this time.
- Repeat **Steps 2 – 5** for rear Mounting Bracket installation. **NOTE:** If you re not sure which sets of mounting holes to use, (last set along cab), hold the driver Sidebar up in the approximate location and line up the threaded inserts in the Sidebar with the holes in the pinch weld.
- Carefully unwrap and position the Sidebar onto the (2) Mounting Brackets. Bolt the Sidebar to the Brackets with (4) 8mm x 25mm Hex Bolts, (4) 8mm Lock Washers, and (4) 8mm Flat Washers, **(Figures 5 & 6)**. Do not tighten at this time.
- Level and adjust the Sidebar properly and tighten all hardware.
- Repeat **Steps 2 – 8** for passenger Sidebar installation.
- Do periodic inspections to the installation to make sure that all hardware is secure and tight.

To protect your investment, wax this product after installing. Regular waxing is recommended to add a protective layer over the finish. Do not use any type of polish or wax that may contain abrasives that could damage the finish.

For stainless steel: Aluminum polish may be used to polish small scratches and scuffs on the finish. Mild soap may be used also to clean the Sidebar.

For gloss black finishes: Mild soap may be used to clean the Sidebar.

Driver Side Installation Pictured

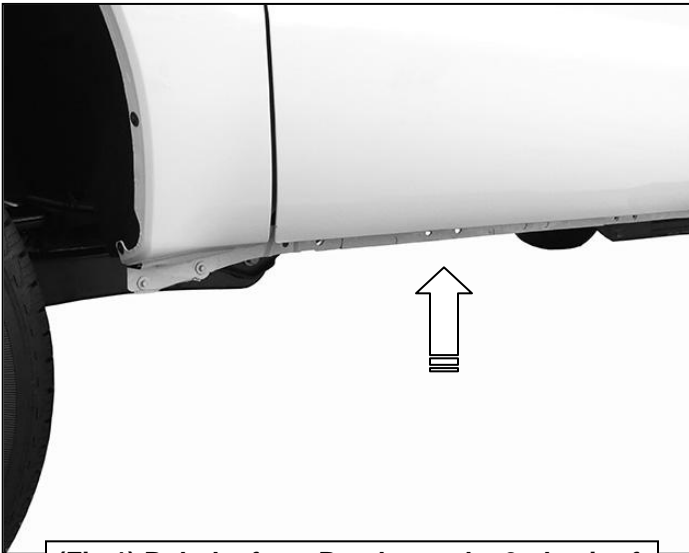

(Fig 1) Bolt the front Bracket to the 2nd pair of factory holes in the bottom of the pinch weld

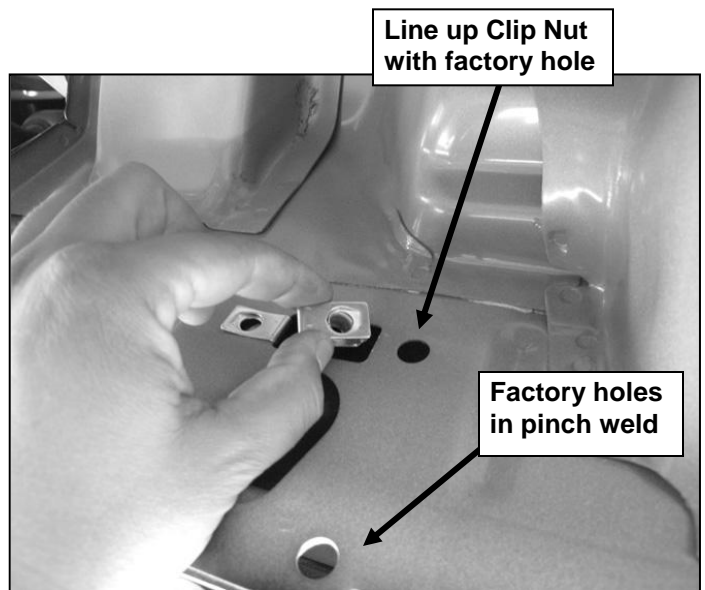

(Fig 2) Typical Mounting Location

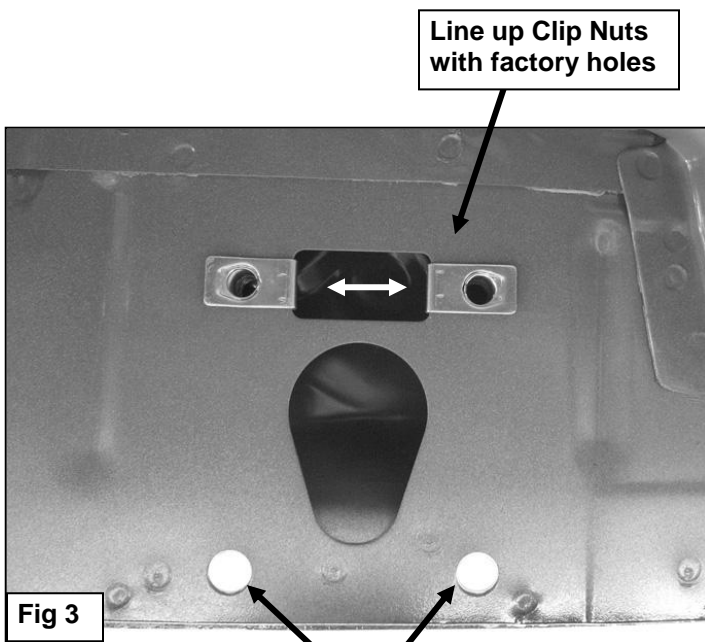

Fig 3

Factory holes in pinch weld pictured from behind

Driver Side Installation Pictured

- (2) 8mm Clip Nuts
- (2) 8mm x 30mm Hex Bolts
- (2) 8mm Lock Washers
- (2) 8mm Flat Washers

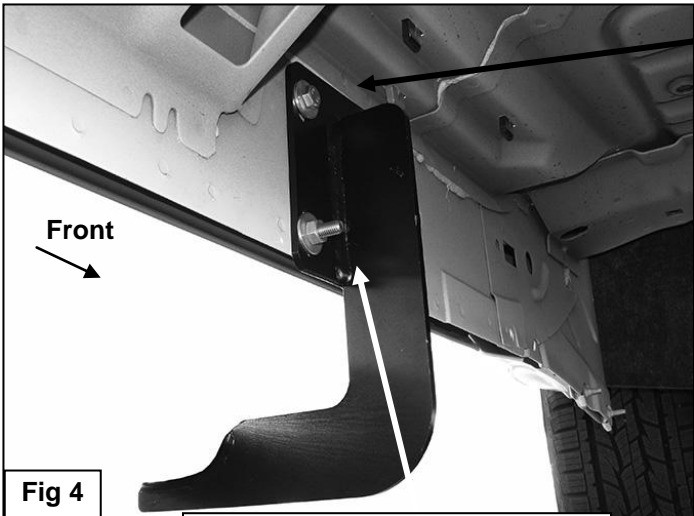
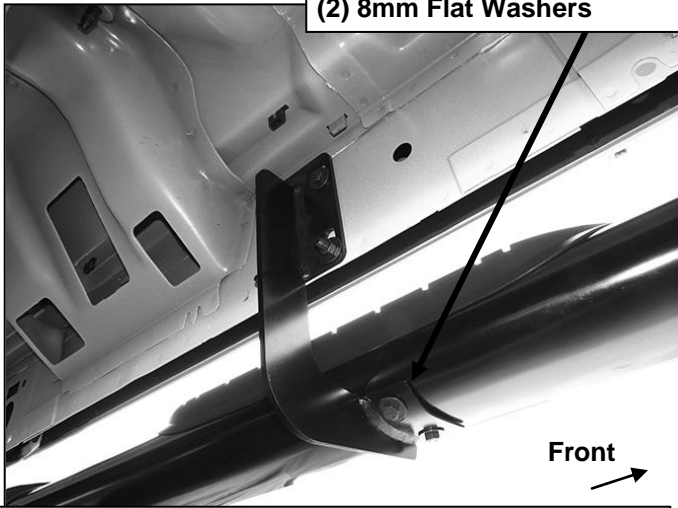

Fig 4

- Attach bottom of Bracket to holes through pinch weld with:
- (2) 8mm x 30mm Hex Bolts
- (4) 8mm Flat Washers
- (2) 8mm Lock Washers
- (2) 8mm Hex Nuts

- (2) 8mm x 25mm Hex Bolts
- (2) 8mm Lock Washers
- (2) 8mm Flat Washers



(Fig 5) Driver/left front Bracket installation pictured

- (2) 8mm x 25mm Hex Bolts
- (2) 8mm Lock Washers
- (2) 8mm Flat Washers

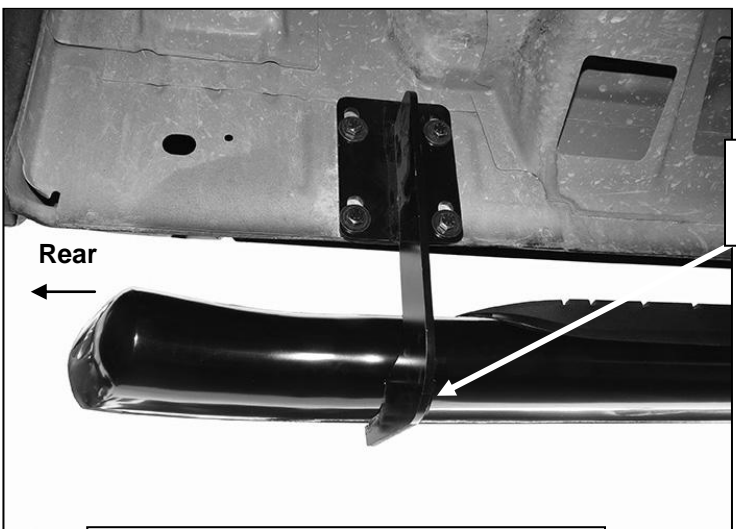

(Fig 6) Driver/left rear Bracket pictured



Complete Installation