

15-18 Ford F150 Regular Cab  
17-18 F250/350/450/550 SUPER DUTY REG CAB

## Rattler Steel Running Boards

### PARTS LIST:

2	Steel Running Boards	12	8mm x 24mm x 2mm Washer
4	Mounting Brackets (left or right)	12	8-1.25mm Nylon Lock Nut
4	6mm Double Bolt Plates	8	6mm x 22mm x 2mm Flat Washers
12	8mm Plastic Retainers	8	6mm Lock Washers
		8	6mm Hex Nuts

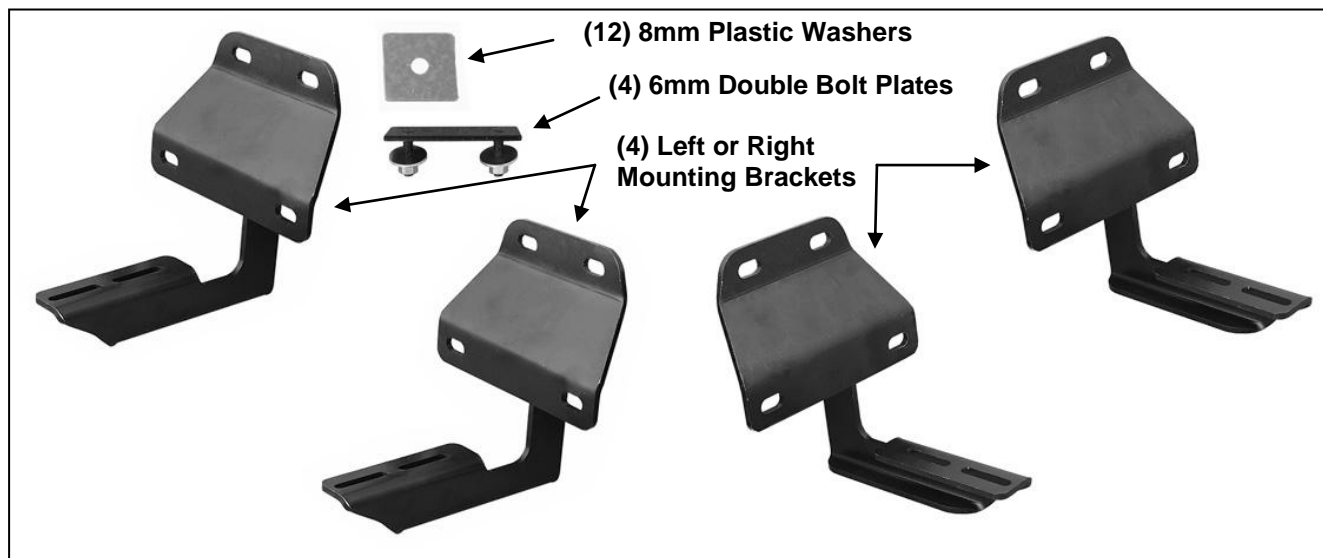

### PROCEDURE:

**REMOVE CONTENTS FROM BOX. VERIFY ALL PARTS ARE PRESENT. READ INSTRUCTIONS CAREFULLY BEFORE STARTING INSTALLATION. ASSISTANCE IS RECOMMENDED.**

1. Start the installation under the passenger side of the vehicle. Locate the front factory running board mounting location along the inner side of the body, **(Figure 1)**.
2. Slide (1) Plastic Washer over each of the (3) factory mounting studs in the body panel, **(Figures 2 & 3)**. **IMPORTANT:** The Plastic Washers are designed to prevent corrosion between the aluminum body panel and the steel mounting brackets. **Do not install the Brackets without the Plastic Washers.**
3. Select (1) Mounting Bracket. **NOTE:** All (4) Brackets are universal and will fit left or right side. Attach the Mounting Bracket to the (3) factory studs with (3) 8mm Flat Washers and (3) 8mm Nylon Lock Nuts, **(Figures 4 & 5)**. Leave brackets loose at this time.
4. Repeat **Steps 1—3** to install the remaining rear passenger side Bracket, **(Figure 8)**.
5. Carefully unwrap and select (1) Running Board. Place the Running Board on top of the Brackets. Locate the channels in the bottom of the Running Board. Select (2) 6mm Double Bolt Plates, **(Figure 6)**. Insert the Bolt Plates into the channels in the bottom of the Running Board closest to the Brackets, **(Figure 7)**. Lift the Running Board up and guide the studs through the Brackets.
6. Attach the Running Board to the Brackets with (4) 6mm Flat Washers, (4) 6mm Lock Washers and (4) 6mm Hex Nuts, **(Figure 8)**. **NOTE:** The Running Board is designed to fit close to the vehicle. It may be necessary to loosen the Bracket hardware slightly and tilt the Brackets downward to insert the Running Board between the Brackets and the body.

- 7. Level and adjust the Running Board as necessary and fully tighten all hardware.
  - 8. Repeat **Steps 1—7** for the driver side Running Board installation.
  - 9. Do periodic inspections to the installation to make sure that all hardware is secure and tight.
- To protect your investment**, wax this product after installing. Regular waxing is recommended to add a protective layer over the finish. Do not use any type of polish or wax that may contain abrasives that could damage the finish. Mild soap may be used also to clean the Running Board.

**Passenger/right Side Installation Pictured**

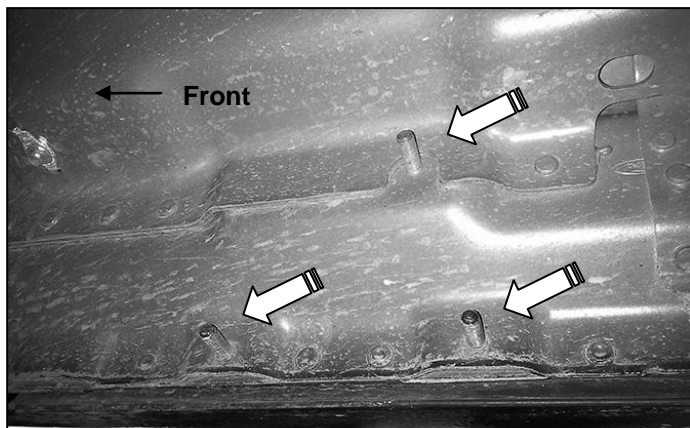

**(Fig 1) Passenger side front mounting location**

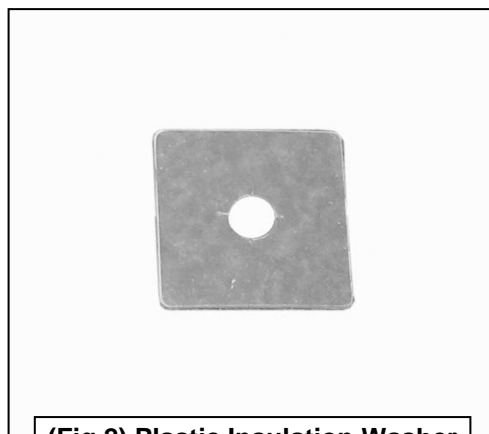

**(Fig 2) Plastic Insulation Washer**

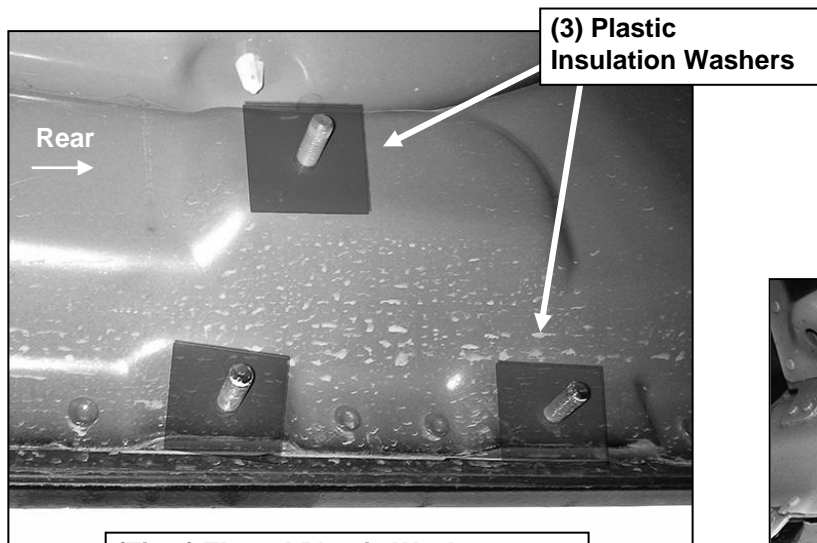

**(Fig 3) Thread Plastic Washers onto all mounting studs. Passenger side rear mounting location pictured**

- (3) 8mm Plastic Washers
- (3) 8mm Flat Washers
- (3) 8mm Nylon Lock Nuts

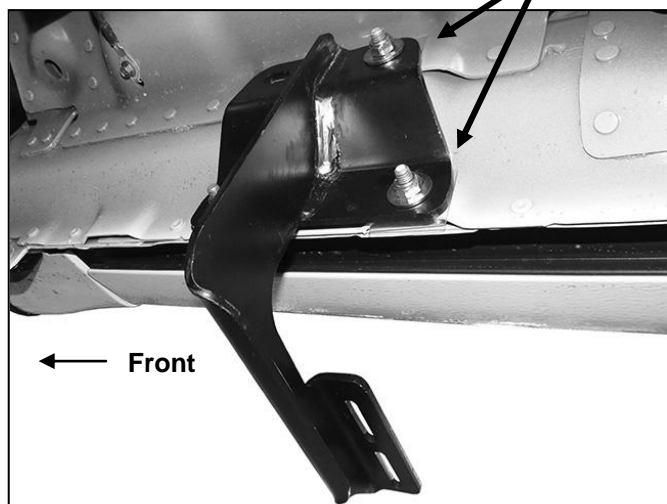

**(Fig 4) passenger side front Bracket installation**

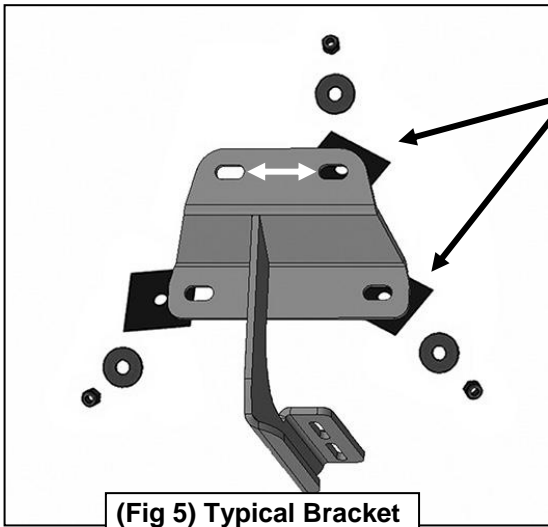

(Fig 5) Typical Bracket installation illustrated

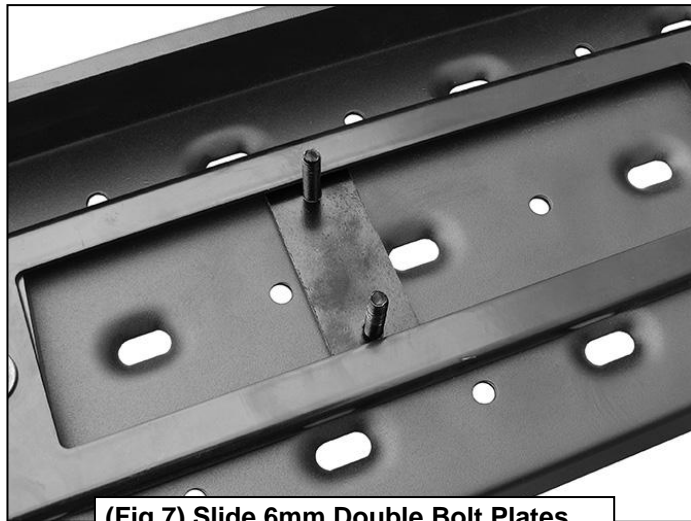

(Fig 7) Slide 6mm Double Bolt Plates into track on bottom of Running Board

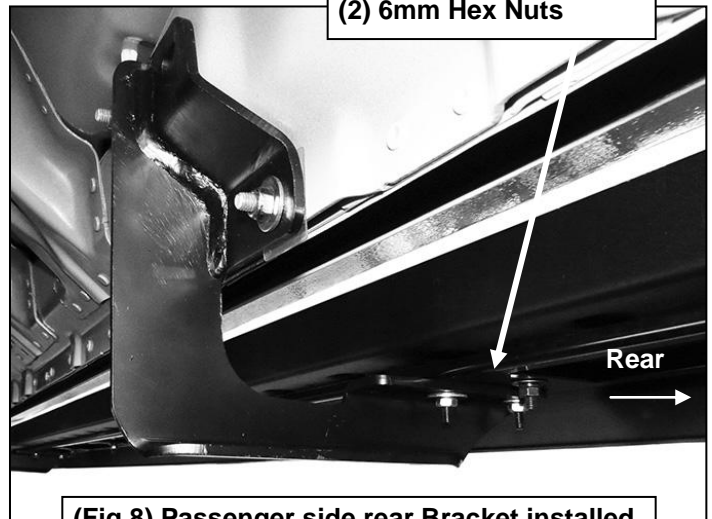

(Fig 8) Passenger side rear Bracket installed

