

PARTS LIST:

PART#T102095 T102090

1	Grille Guard	4	10mm Plastic Washers
1	Driver/Left Frame Mounting Bracket	4	10mm x 27mm x 3mm Flat Washers
1	Passenger/Right Frame Mounting Bracket	2	10-1.5mm Nylon Lock Nuts
1	Driver/Left Top Bracket	4	12mm Plastic Washers
1	Passenger/Right Top Bracket	2	12mm Double Nut Plates
1	Driver/Left Top Support Bracket	2	12mm x 35mm Bolt Plates
1	Passenger/Right Top Support Bracket	10	12-1.75mm x 35mm Hex Bolts
1	Driver/Left Top Support Brace	2	12mm ID x 42mm x 42mm x 5.75mm Square Washers
1	Passenger/Right Top Support Brace	10	12mm x 32mm OD x 3mm Flat Washers
1	50mm x 75mm x 1.0mm Adhesive Foam Tape	12	12mm Lock Washers
2	10mm Quick Release Bolts	2	12mm Hex Nuts
2	10mm Special Pivot Washers		

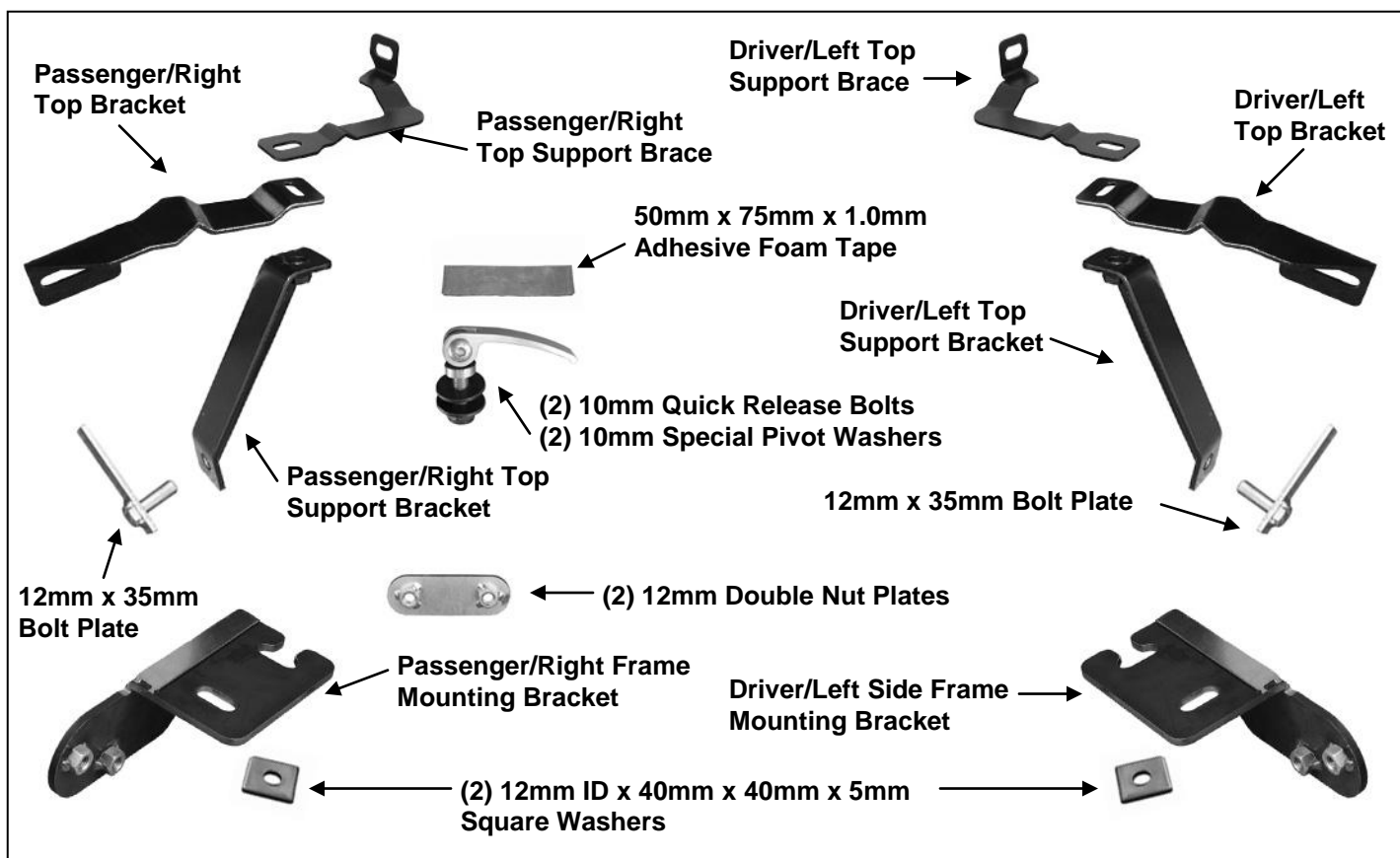

PROCEDURE:

REMOVE CONTENTS FROM BOX. VERIFY ALL PARTS ARE PRESENT. READ INSTRUCTIONS CAREFULLY BEFORE STARTING INSTALLATION. ASSISTANCE IS RECOMMENDED. CUTTING IS REQUIRED ON VEHICLES WITHOUT TOW HOOKS. LICENSE PLATE MUST BE RELOCATED ON VEHICLES EQUIPPED WITH ECOBOOST.

WARNING! This Grille Guard is designed to tilt forward to open the hood for service. The Top Bracket Quick Release Bolts and the upper bolts on the Frame Mounting Brackets will need to be loosened slightly to rotate the Grille Guard. Make sure that all hardware is fully tightened after closing the hood before moving vehicle. **Please read Page 8, "Opening and Closing of Hood,"** before installing the Grille Guard.

NOTE: It may be necessary to remove/relocate the front license plate and license plate bracket. It is not required, but strongly recommended. If local/state law requires a license plate, a license plate relocation kit is available.

1. Determine if the vehicle is or is not equipped with factory tow hooks.

Installation on vehicles with Factory Tow Hooks:

- a. Remove the driver side tow hook, **(Figure 1)**. **NOTE:** This Grille Guard is not compatible with the factory tow hooks and they will not be reinstalled.
- b. Insert (1) 12mm x 35mm Hex Bolt, (1) 12mm Lock Washer and (1) 12mm Square Spacer into the rear hole in the bottom of the frame and up into the factory nut plate, **(Figures 2A & 2B)**. Leave completely loose. Select the driver side Frame Mounting Bracket. Slide the slotted end of the Bracket under the Hex Bolt and Square Washer. Insert (1) 12mm x 35mm Hex Bolt, (1) 12mm Lock Washer and (1) 12mm Flat Washer into the remaining forward hole in the Bracket and into the Nut Plate, **(Figure 3)**. Snug but do not tighten the hardware at this time.
- c. Repeat **Steps a – b** for passenger side Frame Bracket installation.

Installation on vehicles without Tow Hooks:

- a. Remove the lower plastic portion of the bumper and air dam, **(Figure 4)**.
 - b. Insert (1) 12mm Double Nut Plate through the opening in the front end of the driver side of the frame, **(Figures 5A & 5B)**. Line up the threaded holes with the holes in the bottom of the frame.
 - c. Insert (1) 12mm x 35mm Hex Bolt, (1) 12mm Lock Washer and (1) 12mm Square Spacer into the rear hole in the bottom of the frame and up into the Double Nut Plate, **(Figures 2A & 2B)**. Leave completely loose. Select the driver side Frame Mounting Bracket. Slide the slotted end of the Bracket under the Hex Bolt and Square Washer, **(Figure 3)**. Insert (1) 12mm x 35mm Hex Bolt, (1) 12mm Lock Washer and (1) 12mm Flat Washer into the empty remaining forward hole in the Bracket and Nut Plate. Snug but do not tighten the hardware at this time.
 - d. Repeat **Steps a – c** for passenger side Frame Mounting Bracket installation.
 - e. Do not reinstall the plastic lower bumper cover at this time, (See **Steps 12a & 12b**).
2. Open the front hood on the vehicle. Locate the top of the bumper bracket behind the driver side of the front bumper. Locate the open hole in the top outer end of the bumper bracket, **(Figure 6)**. Insert (1) 12mm x 35mm Bolt Plate down and into the gap at the top of the bracket and out through the hole with the threaded end of the Bolt Plate facing to the rear toward the radiator, **(Figures 7A & 7B)**. Slide the lower end of the driver side Top Support Bracket, (end with hole), over the Bolt Plate. Secure the Bracket to the Bolt Plate with (1) 12mm Flat Washer, (1) 12mm Lock Washer and (1) 12mm Hex Nut, **(Figure 8)**. **IMPORTANT:** Do not tighten hardware at this time.

NOTE: Before proceeding, cover the top of the plastic bumper, (driver and passenger sides), with removable tape, (masking tape for example), to protect the bumper during Top Bracket installation, **(Figure 8)**. Next, apply a section of the included Adhesive Backed Foam Tape to the bottom of both Top Brackets to prevent damage to the painted finish on the vehicle, **(Figure 10)**.

3. Select the driver side Top Support Brace, **(Figure 9A)**. Remove the factory hex bolt in the radiator mount. Bolt the Support Brace in place with the factory hex bolt, **(Figure 9B)**. Leave loose at this time.
4. Select the driver side Top Bracket. Insert the Top Bracket between the Support Bracket and the Rear Brace, **(Figure 10)**. Line up the (3) holes and bolt the Brackets together with (1) 12mm x 35mm Hex Bolt, (1) 12mm Lock Washer and (1) 12mm Flat Washer, **(Figure 9B)**. **IMPORTANT:** Do not tighten hardware at this time.

NOTE: It may be necessary to raise or lower the height of the Top Bracket to fit properly between the grille and the top of the bumper. Loosen the 12mm Hex Nut attaching the bottom of the Support Bracket to the Bolt Plate, **(Figure 8)**. Move the Top Bracket up or down as needed to clear the top of the bumper and line up with the Grille Guard before tightening the hardware. Do not fully tighten Top Bracket hardware until after all hardware has been installed and the Grill Guard properly aligned and adjusted.

5. Repeat **Steps 2 – 4** for passenger side Top Bracket, Support Bracket and Top Brace installation.
6. With assistance, place the Grille Guard face down on a clean surface in front of the vehicle, **(Figure 11)**. Position the mounting tabs on the Grille Guard up to the outside of the Frame Mounting Brackets.
7. Line up the rear threaded hole in the driver side Frame Mounting Bracket with the hole in the Grille Guard, **(Figure 12)**. Insert (1) 12mm Plastic Washer between the Mounting Bracket and the Grille

Guard. Bolt the Grille Guard to the driver side Bracket with (1) 12mm x 35mm Hex Bolt, (1) 12mm Lock Washer and (1) 12mm Flat Washer, **(Figure 12)**. Snug but do not tighten hardware at this time.

8. Repeat **Step 7** to attach the Grill Guard to the passenger side Bracket.
9. Use the two previously installed Hex Bolts as a hinge. Rotate the Grille Guard up to the vehicle, **(Figure 11)**. Line up the remaining hole in each Bracket with the Grille Guard. Insert a 12mm Plastic Washer between the Mounting Bracket and the Grille Guard on both sides of the vehicle as described in **Step 7**. Bolt the Grille Guard to the Brackets with (2) 12mm x 35mm Hex Bolts, (2) 12mm Lock Washers and (2) 12mm Flat Washers. Do not tighten hardware at this time.
10. Next, line up the slotted end of the driver side Top Bracket with the hole in the Grille Guard upright. Insert (1) 10mm Plastic Washer between the Top Bracket and the Grille Guard, **(Figure 13)**. Line up the hole in the Plastic Washer with the hole in the Grille Guard and the slot in the Top Bracket. Insert (1) 10mm Quick Release Bolt, (1) 10mm Special Pivot Washer and (1) 10mm Flat Washer through the upright on the Grille Guard first and on through the Plastic Washer and Top Bracket. Secure the Quick Release Bolt with (1) 10mm Plastic Washer, (to protect the finish on the Top Bracket), (1) 10mm Flat Washer and (1) 10mm Nylon Lock Nut, **(Figures 14A & 14B)**. Do not tighten hardware at this time.
11. Repeat **Step 10** for the passenger side Quick Release installation.
12. With the hood open, push the Grille Guard back until it is vertical. Align, center and adjust the Grille Guard properly and tighten all Mounting Bracket and Support Bracket hardware.

Vehicles without tow hooks:

- a. Once the Frame Brackets are fully tightened to the vehicle, temporarily remove only the Grille Guard. Hold the plastic lower bumper cover up in the approximate position against the bottom of the bumper and against the Brackets, (If cover was previously removed in **Step 1a**). Mark the Bracket location onto the back of the bumper cover. Cut slots through the cover to clear the Brackets, **(Figure 15)**. **IMPORTANT:** For best results, start with a small opening and only trim away material required for Bracket clearance. Once properly trimmed, reinstall plastic bumper cover with the factory hardware.
 - b. Reinstall the Grille Guard and tighten all Mounting Bracket and Support Bracket hardware.
13. Release the levers on the Quick Release Bolts, **(Figure 16)**, and loosen the top Hex Bolts on the Frame Mounting Bracket. **WARNING!** Do not loosen the bolts all the way. Loosen hardware only enough to move the Grille Guard. Damage to the truck or Grille Guard may occur.
 14. Pull the Grille Guard all the way forward, away from the vehicle, **(Figure 17)**.
 15. Carefully close the hood and check for clearance between the Top Bracket and the factory grille. Adjust the Brackets up or down for fit as necessary. **IMPORTANT:** Always make sure that the hood and grille will clear the Grille Guard before closing the hood.
 16. Close the hood. Push the Grille Guard back towards the vehicle until it is vertical, check the alignment again and adjust the Grille Guard as required. Tighten all Mounting Bracket hardware including the Quick Release Bolts, **(Figure 16)**.
 17. Do periodic inspections to the installation to make sure that all hardware is secure and tight.

To protect your investment, wax this product after installing. Regular waxing is recommended to add a protective layer over the finish. Do not use any type of polish or wax that may contain abrasives that could damage the finish.

For stainless steel: Aluminum polish may be used to polish small scratches and scuffs on the finish. Mild soap may be used also to clean the Grille Guard.

For gloss black finishes: Mild soap may be used to clean the Grille Guard.

Driver Side Installation Pictured

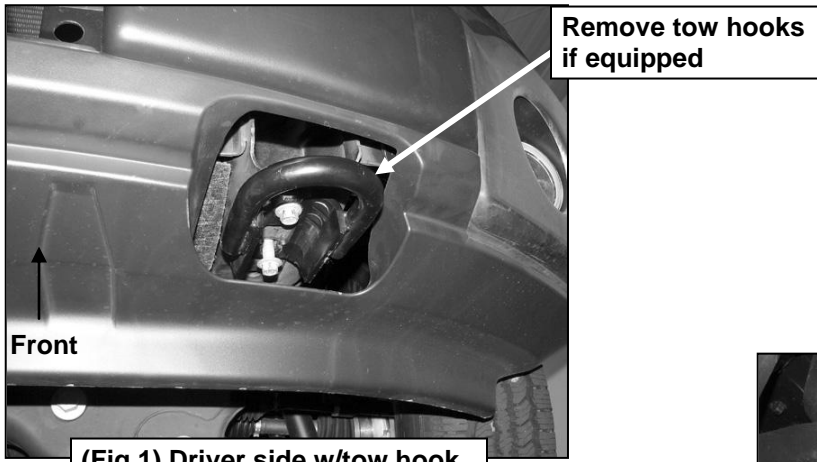

Rear location:
12mm x 35mm Hex Bolt
12mm Lock Washer
12mm Square Washer

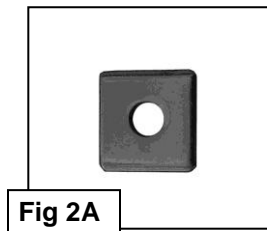
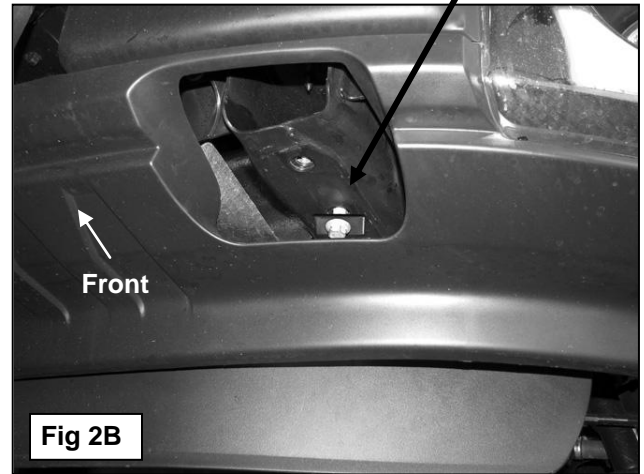

12mm x 35mm Hex Bolt
12mm Lock Washer
12mm Flat Washer

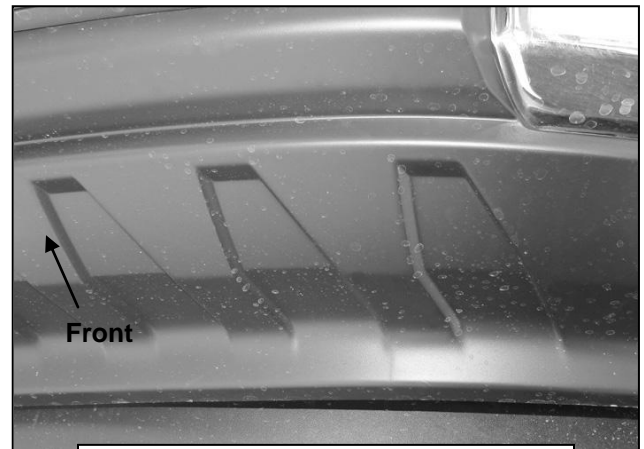
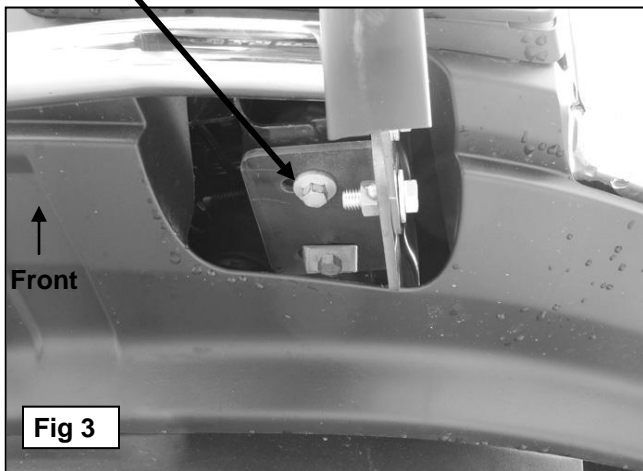

Driver Side Installation Pictured

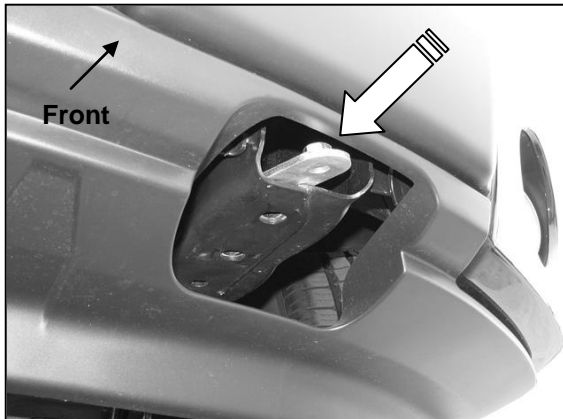

(Fig 5B) Insert Nut Plate through opening in end of frame (NOTE: Tow hook model pictured for instruction purposes only)

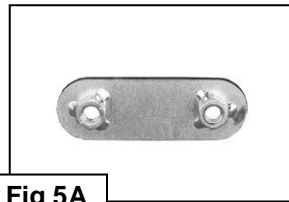
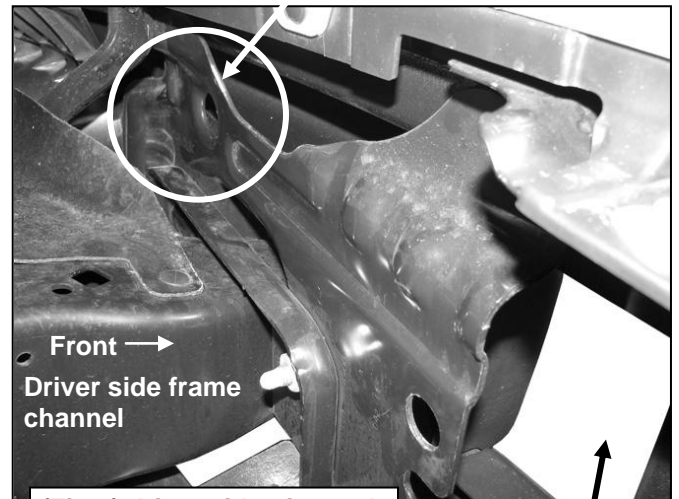

Fig 5A

Insert 12mm Bolt Plate through outermost hole in bumper bracket



(Fig 6) driver side pictured

Opening in center of bumper

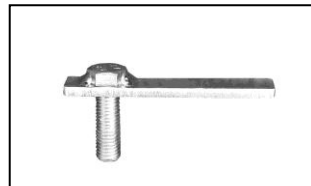

(Fig 7A) 12mm x 35mm Bolt Plate

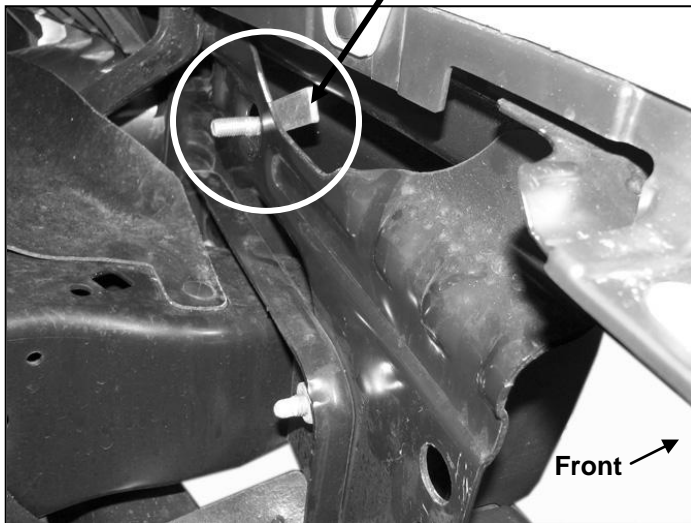

(Fig 7B) Driver side pictured from behind bumper

Cover a section (dotted line) of the top of the bumper with removable tape to prevent damage to finish on bumper

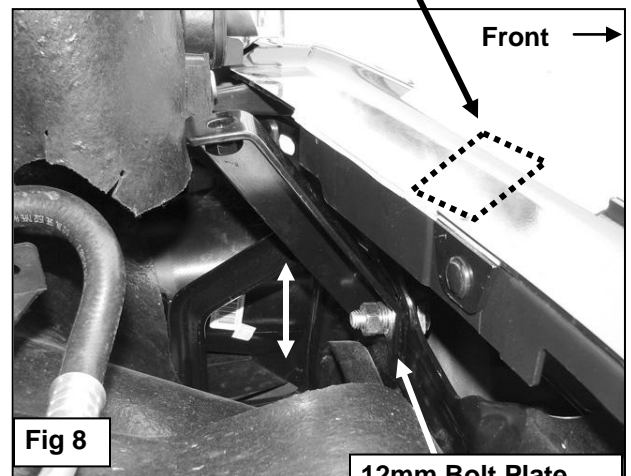
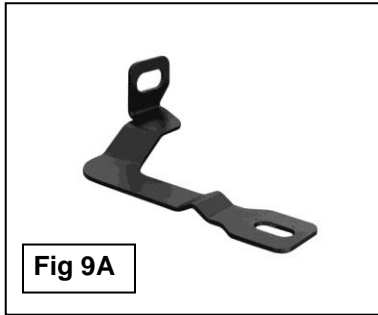

Fig 8

12mm Bolt Plate
12mm Lock Washer
12mm Flat Washer
12mm Hex Nut

Loosen Hex Nut on Bolt Plate (Fig 8) and adjust height of Support Bracket (up or down) as necessary. Do not tighten Hex Nut until final adjustment step.

Driver Side Installation Pictured



Use factory hex bolt

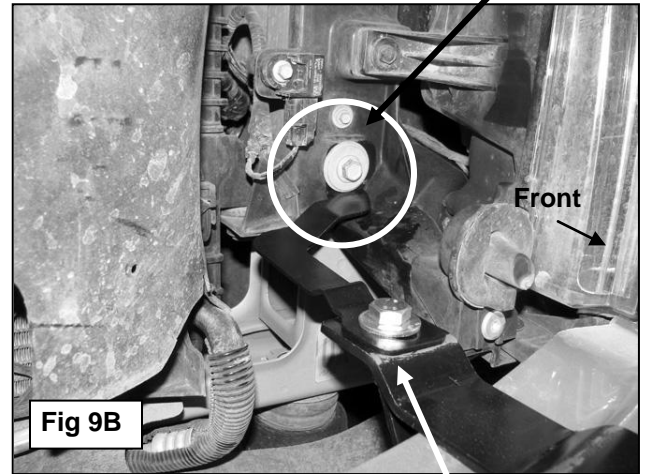

Cover a section (dotted line) of the bottom of the Bracket with Foam Tape to prevent damage to finish on bumper

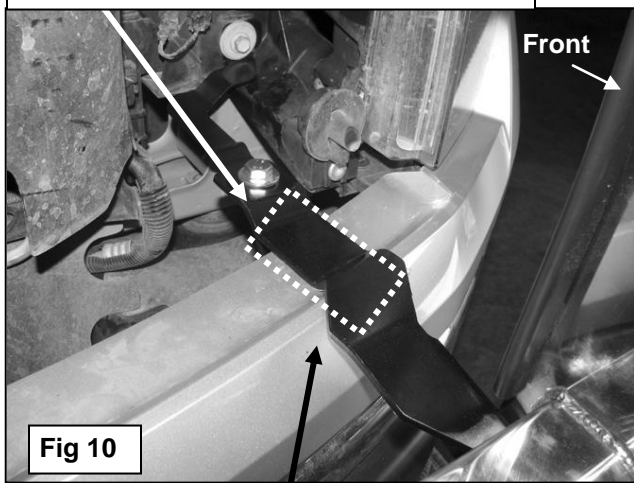

12mm x 35mm Hex Bolt
12mm Lock Washer
12mm Flat Washer

For easier installation, insert (1) 12mm Hex Bolt per side in the location pictured in Figure 8 to act as a hinge. Snug the hardware but do not tighten, then rotate the Grille Guard up into position



Protect the top of the plastic bumper cover with masking tape to prevent scratches during installation

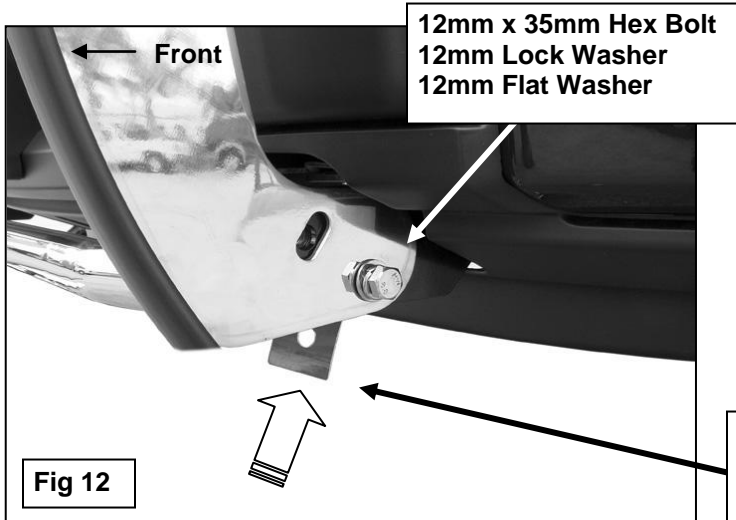

Insert 12mm Plastic Washers between the Grille Guard and the Mounting Bracket. Line up the holes in the Plastic Washers with the mounting holes. Insert the Mounting Bolts through the Plastic Washers

Driver Side Installation Pictured

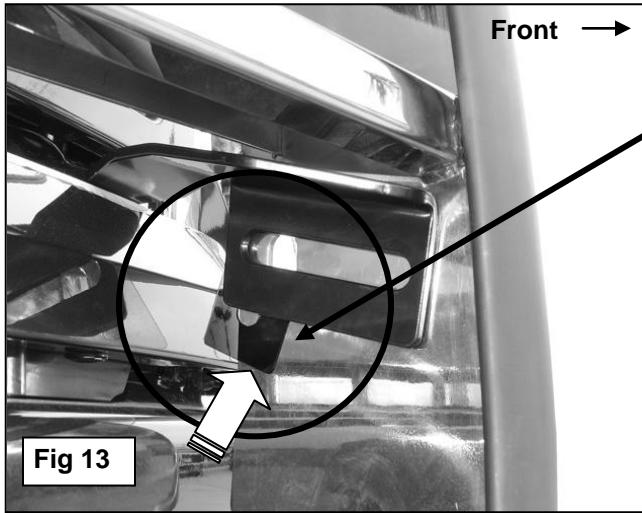

Insert a 10mm Plastic Washer between the Grille Guard and the slotted Top Bracket. Line up the hole in the Plastic Washer with the mounting holes. Insert the Quick Release Bolt through the Plastic Washers

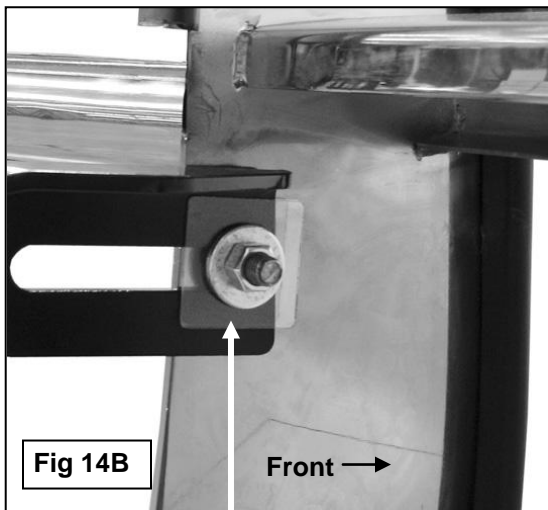
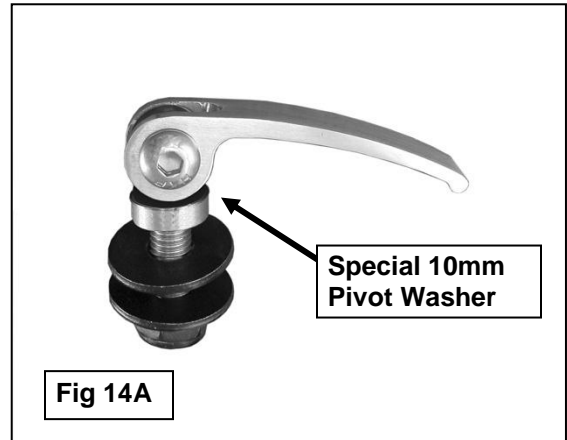

Fig 14B

Place a 10mm Plastic Washer between the slotted Top Bracket and the 10mm Flat Washer to protect the finish on the Top Support Bracket. Inside of upright on Grille Guard pictured

Do not cut through top or bottom edge of bumper cover

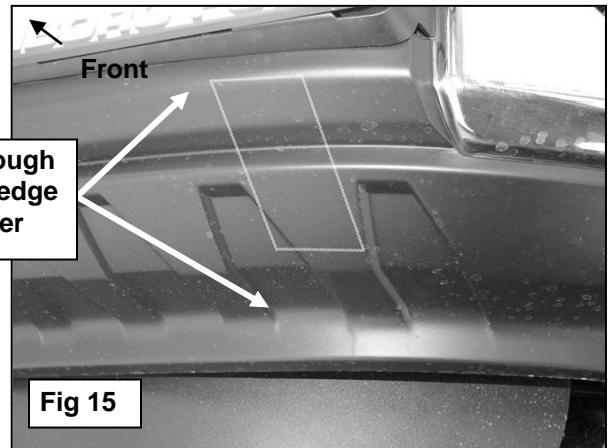
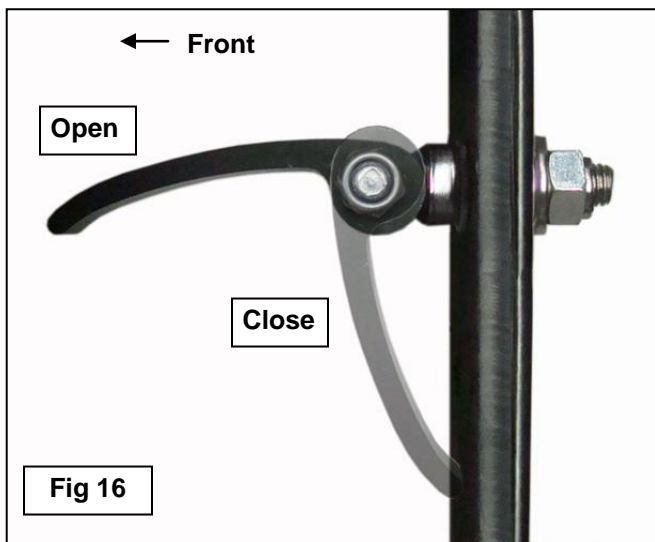

Fig 15

Non tow hook model pictured. Once Grille Guard has been completely installed and lined up properly on the vehicle, tighten only the hardware bolting the Frame Brackets to the frame. Remove the Grille Guard. Hold the plastic lower bumper cover up in the original position against the Brackets. Trace the Frame Bracket locations onto the cover. Cut out the area with sharp knife of hacksaw blade. Cut as little as possible from cover. Do not cut through top or bottom edge. Cut area pictured for example only. Installer responsible for correct modifications

Driver Side Installation Pictured



Tighten or loosen the 10mm Nylon Lock Nut to adjust the clamping pressure on the Quick Release Bolt. When properly adjusted, it should require reasonable force (by hand only) to completely close the lever



To open the hood, release the lever on the Quick Release Bolts. Try to pull the Grille Guard forward. If necessary, loosen the Hex Bolts securing the Grille Guard to the Mounting Brackets. Only loosen the hardware enough to move the Grille Guard



Opening and closing the hood

1. Lift the levers on the two Quick Release Bolts to release clamping pressure, **(Figure 16)**. Try to pull the Grill Guard forward. If necessary, slightly loosen the top hex bolts on the Frame Mounting Brackets to pivot the Grille Guard away from the vehicle. Carefully pull on the Grille Guard until it is fully extended away from the vehicle, **(Figure 17)**. **WARNING!** Do not loosen the bolts all the way. Damage to the truck or Grille Guard may occur. Only loosen the bolts enough to move the Grille Guard.
2. Pull the hood release and open the hood.
3. **IMPORTANT:** Before closing the hood, always check to make sure that the Grille Guard hasn't been pushed back to its "closed" position and that it is fully extended away from the vehicle, then close the hood.
4. Once the hood is completely closed, push the Grille Guard back to its closed, upright position and tighten all hardware on the Grille Guard. Push down on the Quick Release lever to tighten, **(Figure 16)**. No tools are required to close the Quick Release levers. It will require some effort to open and close by hand when properly adjusted. Loosen or tighten the 10mm Nylon Lock Nut on the Quick Release bolt to adjust the clamping pressure.
5. Do periodic inspections to the installation to make sure that all hardware is secure and tight.