

# UX

## QUICK START INSTALL GUIDE

# FLEX

### 1 Install Parts Check List

- A:** Flex hard folding cover
- B:** Side mounting rails, left and right (pre-assembled)
- C:** Hardware bag & Drain tubes (2)



**Tools Needed:**

1/2" wrench or socket  
 Note: The Flex was designed from trucks that do not have plastic bed liners, some minor trimming may be required to allow the cover to fit properly.

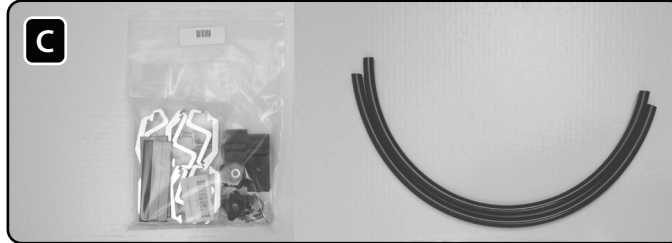
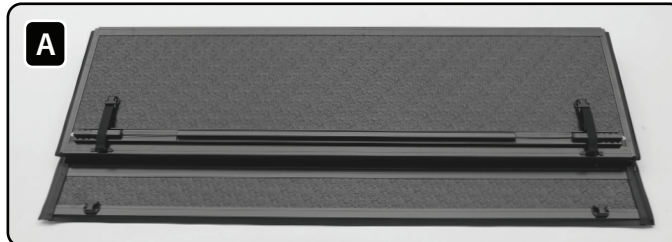

### 2 Attach Side Mounting Rails

Attach both side rails to the truck bed. The rails are left and right specific and have been pre-assembled for your convenience. Note: Refer to the Model Specific Guide for more specific instructions on clamping the rails to the truck.

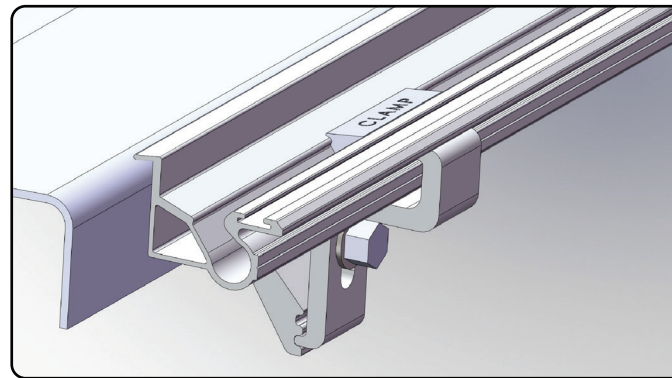
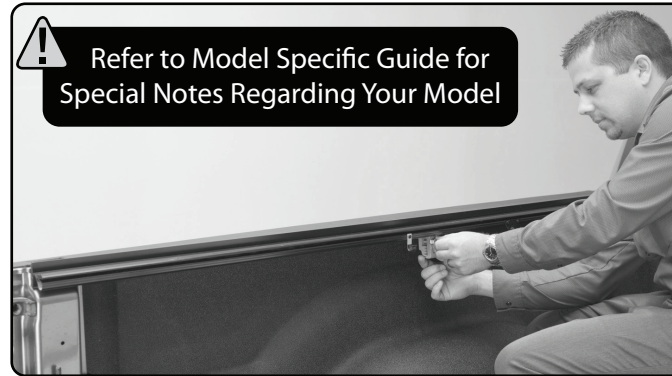

**!** Refer to Model Specific Guide for Special Notes Regarding Your Model

**!** Do not overtighten the clamp assembly.

**!** Clamps must be checked periodically for tightness.

### 3 Install Cover

Slide the two front mounting bolts into the track on the underside of the Flex tonneau cover, one on each side. Place the Flex tonneau onto the mounting rails with the smallest panel towards the cab of the truck and with the front flap covering the bulkhead (front rail of the bed).

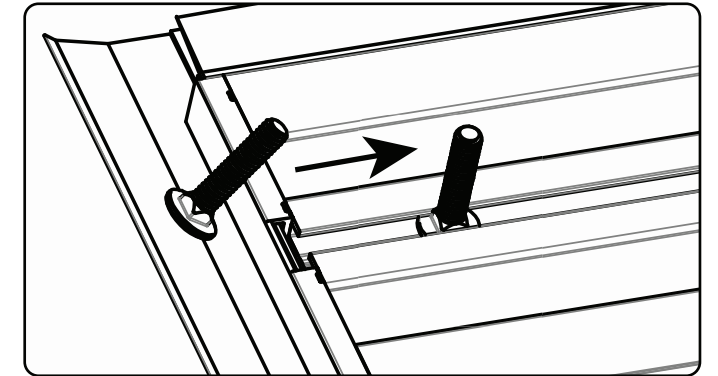

### 4 Unfold Cover and Adjust

Carefully unfold the cover. Unfold each panel and position it so it is centered side to side and front to back on the truck bed.

Test the rear most latching assembly for smooth operation as this is the best indicator of the cover being positioned correctly. Be sure the latches on both sides are engaging with the cover mounting rail.

Note: If your truck is equipped with a tailgate protector, you may need to slightly raise the rear of the side mounting rails for the latches to engage properly.

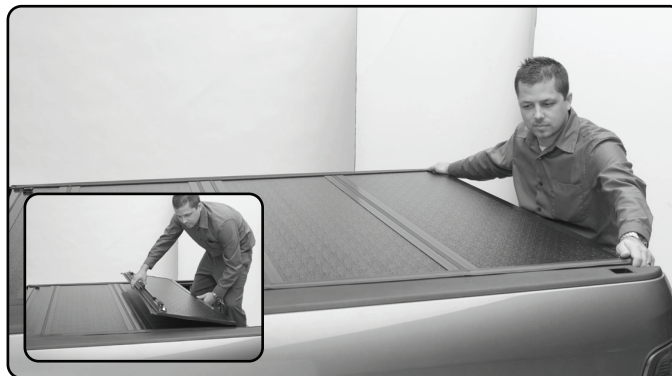

### 5 Fold Cover up to Attach

Once the cover is located correctly, fold the cover up to the open position. Pull the release cables on the each of the three panels to release it from the side rail. Take care to fold it gently so the position of the cover is not disturbed.

Note: You can temporarily lean the cover against the cab to attach mounting hardware.



### 6 Attach Cover/Drain Tubes

Once in the fully open position place a front retainer clamp, flat washer, lock washer and the star knob on the front mounting bolt underneath the cover and hand tighten. Be sure the front retainer clamp is clamping to the side rail correctly. Test the cover again for proper operation, adjust as needed, then tighten the star knobs.

Attach the drain tubes to the fittings at the front of the bed rail and position the tubes to divert water out of the truck bed. This can be done by placing the tube behind a bed liner, through an existing hole in the bed, or by drilling a 5/8" hole in the bulkhead.

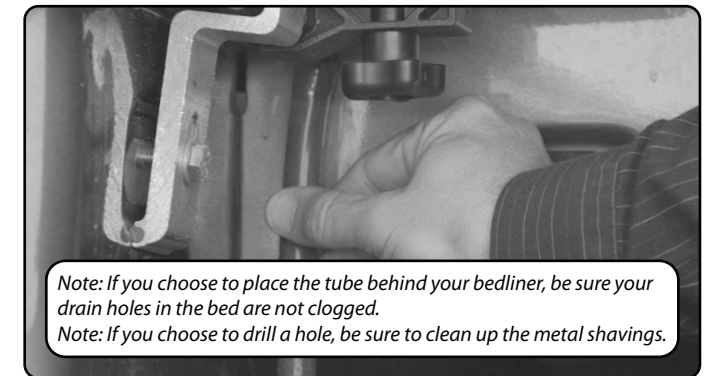
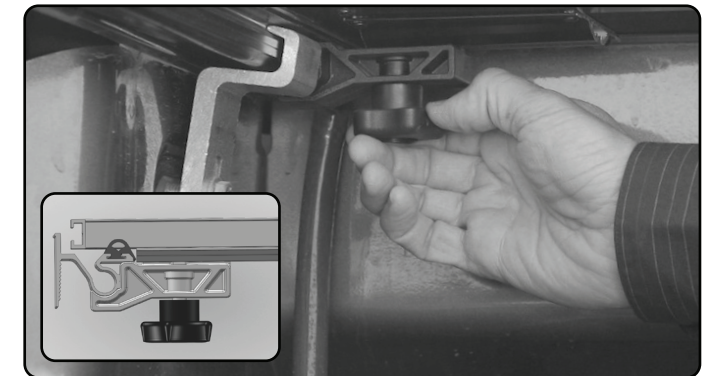

Note: If you choose to place the tube behind your bedliner, be sure your drain holes in the bed are not clogged.  
 Note: If you choose to drill a hole, be sure to clean up the metal shavings.