

# Raptor Series



**Your satisfaction is important to us, please let us help!**

If you have any questions or concerns during the installation, our support representatives are available to assist you.

Please call: 1-877-769-3765 or Live Chat at [www.raptorseries.com](http://www.raptorseries.com)

If you have damaged or missing parts please contact the company you purchased the product from and notify them of the issue right away.



**CAUTION: Do not install damaged parts!!!**

# Raptor Series

## Easy Return / Easy Exchange

---

### **Want to return an item or exchange? Not satisfied with purchase?**

No problem. We strongly believe in service after the sale and we stand behind our products and our service to you, our valued customer. There is no problem we can't solve for you!

Items that have been installed and/or damaged after receipt, are no longer in new and ready-to-sell condition and cannot be refunded, replaced or exchanged unless it has a manufacturer defect or was damaged in shipping. In addition, we cannot accept return on items that are not in the original packaging. Items returned in poor condition or having parts missing will not be credited.

**Please note: Your request for return or replacement must be initiated within 30 days of delivery of your merchandise.**

### **Did your order arrive damaged?**

Please do not install damaged products. Contact the company you purchased your product from as soon as possible and notify them of the damages. They will make arrangements with you to assist with the problem.

### **Did you order the wrong part or receive the wrong item?**

Don't worry. From time to time human error can result in problems with ordering or shipping. Contact the company you purchased your product from as soon as you notice the error. Every company has their own policy on returning parts that have been ordered incorrectly or shipped incorrectly.

In the event that you need to ship your part back to return/exchange, please ship to the warehouse below:

**CYC Returns Warehouse  
2415 Cathy Lane  
Jasper, IN 47546**

The logo for the Raptor Series, featuring the word "Raptor" in a green, cursive font and "Series" in a black, bold, sans-serif font below it. The background of the logo is a faint, light green silhouette of a raptor in flight.

# Raptor Series

## Raptor Series Warranty

### LIMITED TEN (10) YEAR WARRANTY

#### For Powder Coated Steel Products

CYC Engineering, Inc. guarantees the original purchaser of our products a limited ten (10) year warranty from the date of original purchase against manufacturer defects in materials, workmanship and finish under normal use. The step pads are covered under warranty for 1 year. This warranty does not include damage resulting from road hazards such as gravel or other debris, product misuse, improper installation, impairments from accidents, product modifications, product neglect or scratches during the life of the product. This limited ten year warranty applies only to new products and is limited to the repair or replacement of company's products. Warranty does not include costs of removal, installation, labor, inconvenience or consequential damages. Original purchaser must return defective merchandise along with the purchase receipt, to the original place of purchase.

### LIMITED LIFETIME WARRANTY

#### For Stainless Steel Products







CYC Engineering, Inc. guarantees the original purchaser of our products a limited lifetime warranty from the date of original purchase against manufacturer defects in materials, workmanship and finish under normal use. The step pads are covered under warranty for 1 year. This warranty does not include damage resulting from road hazards such as gravel or other debris, product misuse, improper installation, impairments from accidents, product modifications, product neglect or scratches during the life of the product. This limited lifetime warranty applies only to new products and is limited to the repair or replacement of company's products. Warranty does not include costs of removal, installation, labor, inconvenience or consequential damages. Original purchaser must return defective merchandise along with the purchase receipt, to the original place of purchase.

1202-0173, 1202-0173B









# 6" OVAL BAR

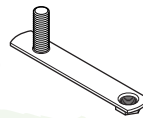
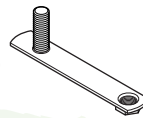





### Components:

-  Driver Side Step Bar Qty 1
-  Passenger Side Step Bar Qty 1
-  Driver Side - Rear Bracket Qty 1
-  Driver Side - Front & Center Bracket Qty 2
-  Passenger Side - Front & Center Bracket Qty 2
-  Passenger Side - Rear Bracket Qty 1
-  Rubber Gasket Qty 6

### Hardware:

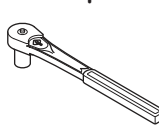
-  M8 x 40MM Hex Head Bolt Qty 6
-  M12 Bolt + M10 Nut Plate Qty 6
-  M12 Flat Washers Qty 6
-  M12 Lock Washers Qty 6
-  M12 Hex Head Nut Qty 6
-  Plastic Push Nut Qty 6
-  M10 x 40MM Hex Head Bolt Qty 6
-  M10 x 30MM Button Head Bolts Qty 12
-  M10 Flat Washers Qty 18
-  M10 Lock Washers Qty 18

### Tools Required:

-  RATCHET
-  TORQUE WRENCH
-  19MM SOCKET
-  17MM SOCKET
-  6MM HEX BIT

### Torque Specifications:

For Rocker Panel Mount Installations  
M8 through M12 bolts and nuts are set to 15-20 ft lbs.

**Note: When installing the brackets and bars, all hardware must be left loose until all the items are attached.**

**1.** Remove all contents from the package and check stainless steel tubes for any damage. Also, verify that all components and hardware listed above are included before you begin installation.

**2.** Locate factory holes in six (6) places underneath body mount.

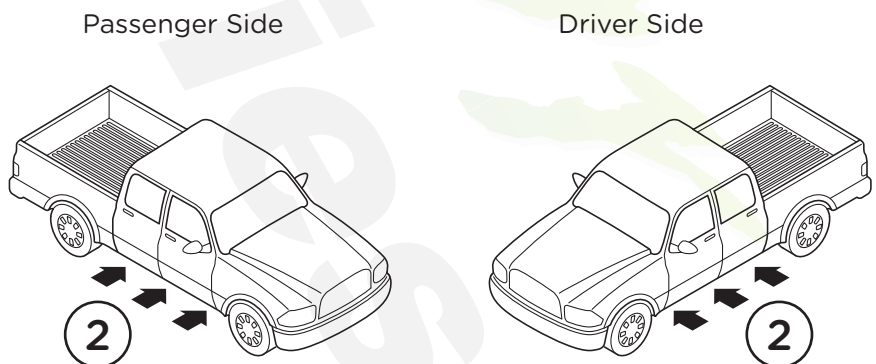

**3.** Remove the **Tape** covering the factory oblong hole in the rocker panel located above the two (2) hex holes.

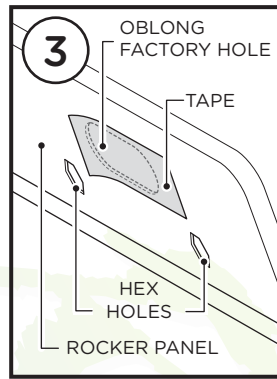

**4.** Place the Plastic Push Nut onto the stud of the M12 Bolt + M10 Nut Plate (4b). Then, slide the M12 Bolt + M10 Nut Plate into the hole in the rocker panel as shown (4a).

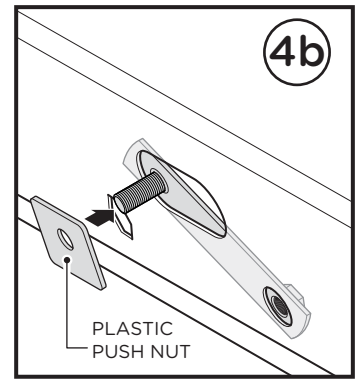
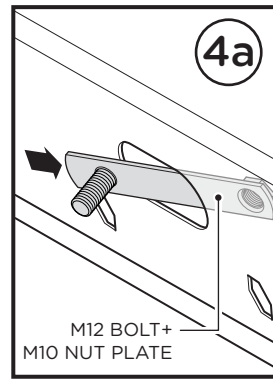

**5.** Front & Center Bracket Cradle face to the rear of truck and Rear Bracket Cradle truck.

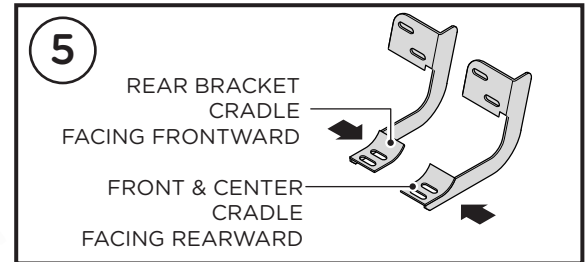

**6.** Begin installation on passenger side. Position Front Bracket, Center Bracket and Rear Bracket as shown along passenger side.

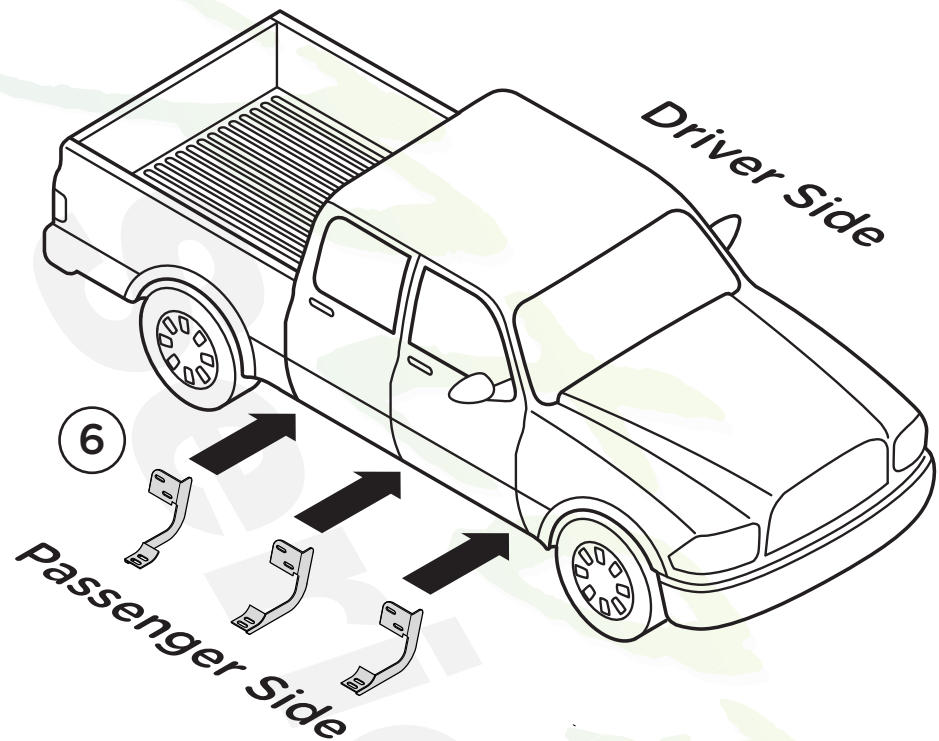

**7.** Line up each bracket to the 12 Bolt + M10 Nut Plate located in the rocker panel.

Fasten the Bracket onto the M12 Bolt using one (1) M12 Flat Washer, one (1) M12 Lock Washer and one (1) M12 Hex Head Nut.

Fasten the Bracket to the threaded nut using one (1) M10 Flat Washer, one (1) M10 Lock Washer and one (1) M10 x 30MM Hex Head Bolt.

If threaded inserts already exist in rocker panel holes, use (1) M8 Flat Washer, one (1) M8 Lock Washer and one (1) M8 x 40MM Hex Head Bolt.

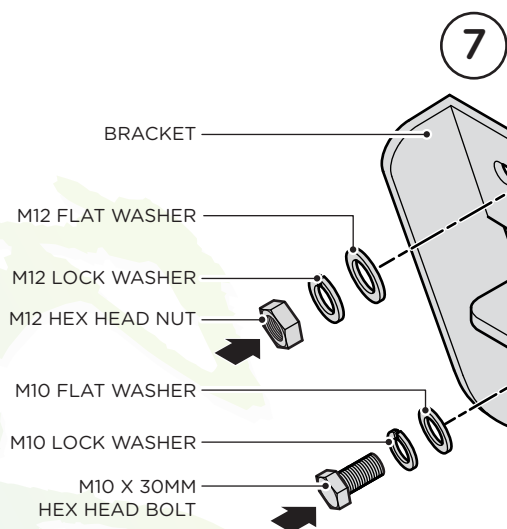

**8.** Place the Rubber Gaskets onto each Bracket Cradle (8a.) Then, place the Step Bar onto the Brackets and fasten using two (2) M10 Flat Washers, two (2) M10 Lock Washers and two (2) M10 x 30MM Button Head Bolts (8b).

Tighten until the split lock washer is flat against bracket and snug. **DO NOT** over tighten and strip the threaded insert in the tube.

Repeat these steps for driver side installation. When all hardware is in place, everything must be tightened. See Page 1 for Torque Specifications.

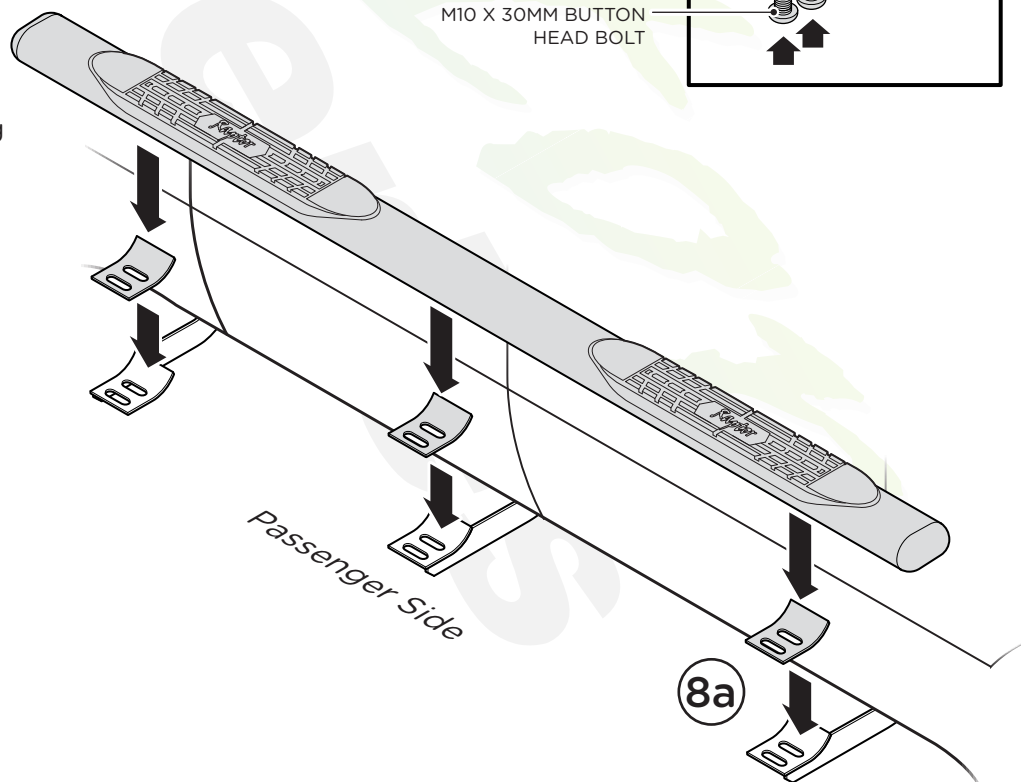
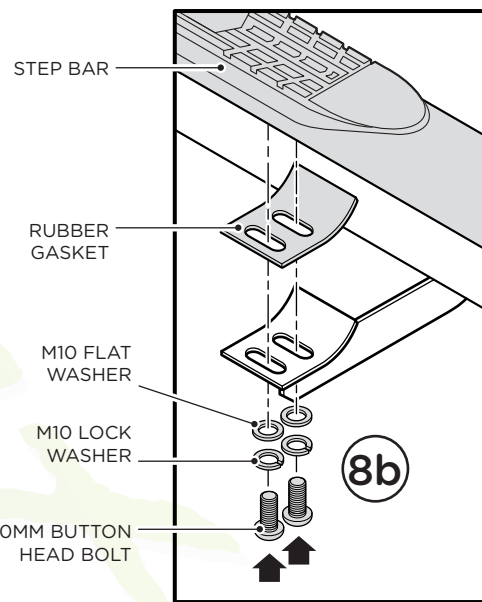

# ADDENDUM

Dodge Ram Trucks Built After June 2015  
With Driver Front Support Brace

## Components:

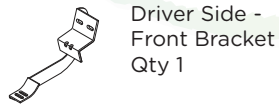

Driver Side -  
Front Bracket  
Qty 1

## Hardware:

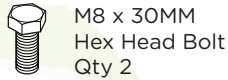

M8 x 30MM  
Hex Head Bolt  
Qty 2



M8 Flat  
Washer  
Qty 2



M8 Lock  
Washer  
Qty 2

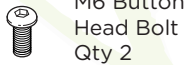

M6 Button  
Head Bolt  
Qty 2

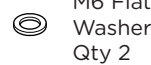

M6 Flat  
Washer  
Qty 2



M6 Lock Nut  
Qty 2

## Tools Required:

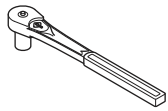

RATCHET



10MM SOCKET

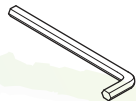

4MM ALLEN  
WRENCH



1/4" DRILL BIT



DRILL

**1.** Align two (2) oblong holes of Bracket with two (2) hex holes on Rocker Panel. Fasten the Bracket to the Rocker Panel using one (1) M8 x 30MM Hex Head Bolt, one (1) M8 Flat Washer and one (1) M8 Lock Washer per hole.

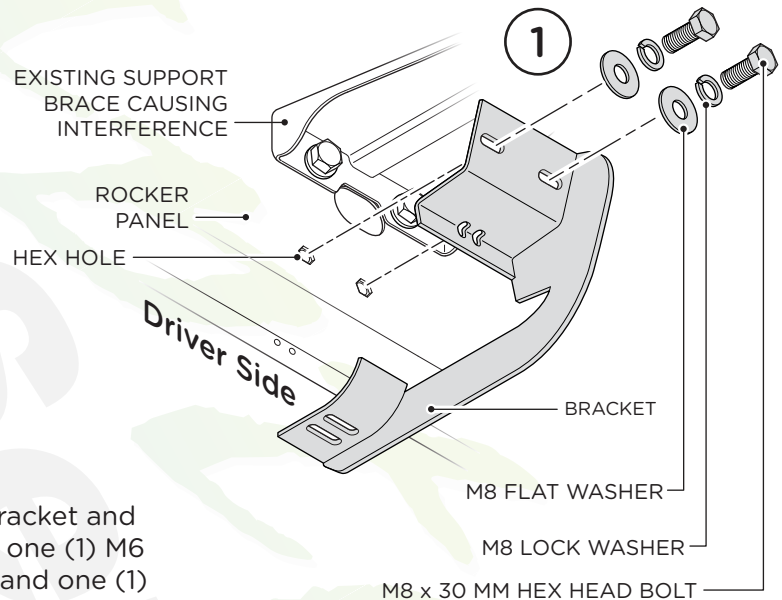

**2.** Locate two (2) holes on underside of Bracket and secure the Bracket to the Pinchweld using one (1) M6 Button Head Bolt, one (1) M6 Flat Washer and one (1) M6 Lock nut per hole.

**NOTE:** If no holes are present in the Pinchweld to accommodate the Button Head Bolts, you must drill two (2) holes into Pinchweld using a 1/4" drill bit (see Fig. 1).

Fig. 1

