



NOT LEGAL FOR SALE OR USE ON ANY POLLUTION CONTROLLED MOTOR VEHICLE IN CALIFORNIA OR STATES ADOPTING CALIFORNIA EMISSION PROCEDURES.
See knfilters.com for CARB status on each part for a specific vehicle

INSTALLATION INSTRUCTIONS

77-3085KP CHEVROLET / GMC 2014 Silverado 1500 2014 Sierra 1500 V6-4.3L

NOTE: This kit was not designed to fit vehicles with a body lift.

TOOLS NEEDED:

- Flat blade screw driver
- Ratchet
- Extension
- 10mm socket
- T15 torx
- 3mm allen

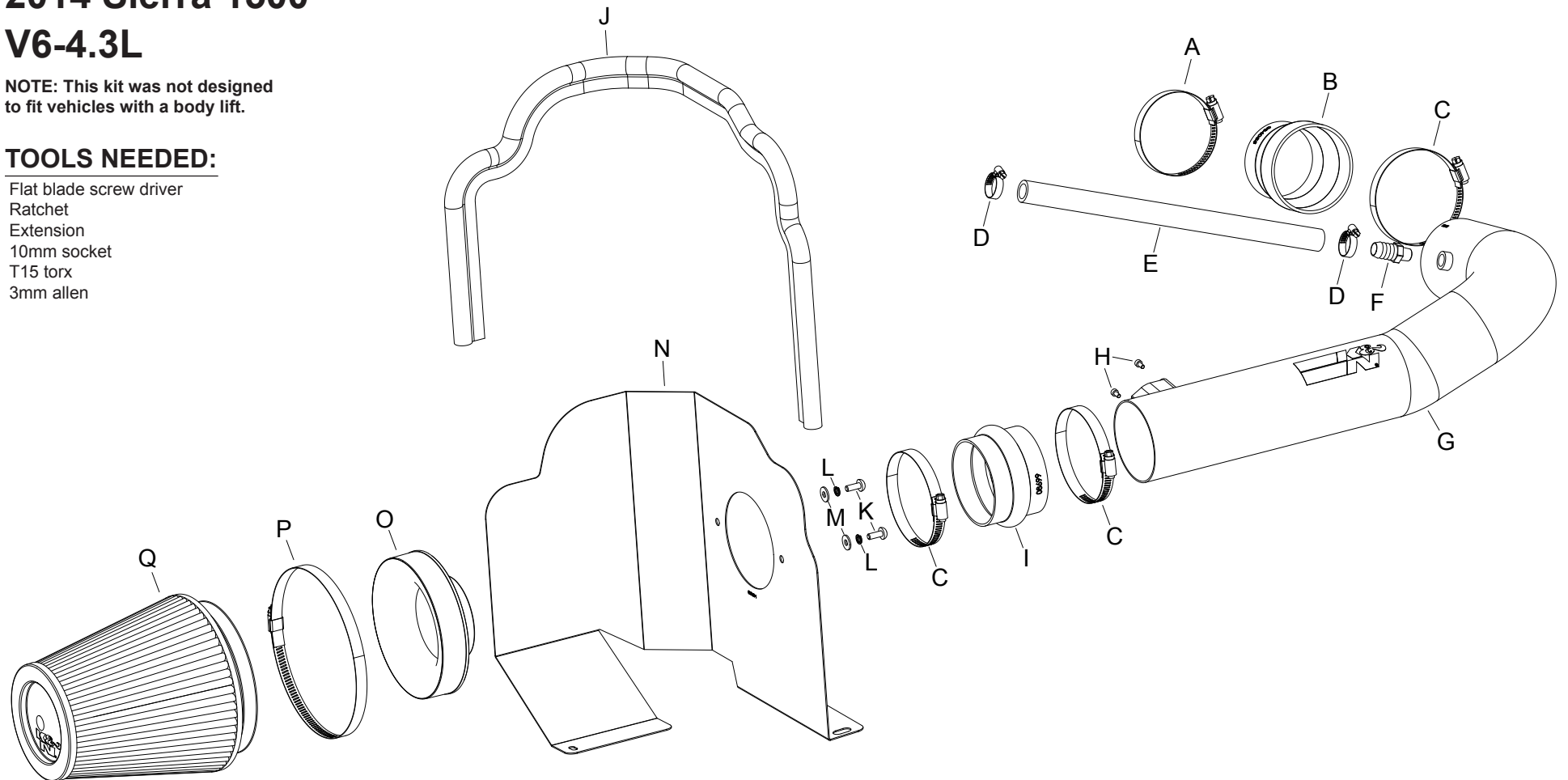

PARTS LIST:

Description	Qty.	Part #	Description	Qty.	Part #	Description	Qty.	Part #
A Hose Clamp #48	1	08601	G Intake Tube	1	27624KP	M Washer; 6MM Flat, SS	2	08269
B Hose; 3-1/2" To 3" ID X 3"L	1	084055	H Bolt; M4- 0.07 8MM, A/H Cap ,SS	2	07733	N Heat Shield	1	073155-1
C Hose Clamp #56	3	08620	I Hose; 3-1/2" ID X 2-1/2"L Hump	1	08699	O Adapter; Universal, 6" Filter 3.5"	1	21512-1
D Hose Clamp #8 Mini	2	08410	J Edge Trim (44")	1	102486	P Hose Clamp # 104	1	08697
E Hose; 5/8" ID X 14"L	1	084083	K Bolt; M6 X 1.00 X 16MM, SS	2	07730	Q Air Filter	1	RF-1041
F Vent; STRT; 5/8 Barbed 1/4" NPT	1	08911	L Washer; M6 Split Lock Zinc	2	1-3025			

NOTE: FAILURE TO FOLLOW INSTALLATION INSTRUCTIONS AND NOT USING THE PROVIDED HARDWARE MAY DAMAGE THE INTAKE TUBE, THROTTLE BODY AND ENGINE.

TO START:

1. Turn off the ignition and disconnect the negative battery cable.

NOTE: Disconnecting the negative battery cable erases pre-programmed electronic memories. Write down all memory settings before disconnecting the negative battery cable. Some radios will require an anti-theft code to be entered after the battery is reconnected. The anti-theft code is typically supplied with your owner's manual. In the event your vehicles anti-theft code cannot be recovered, contact an authorized dealership to obtain your vehicles anti-theft code.

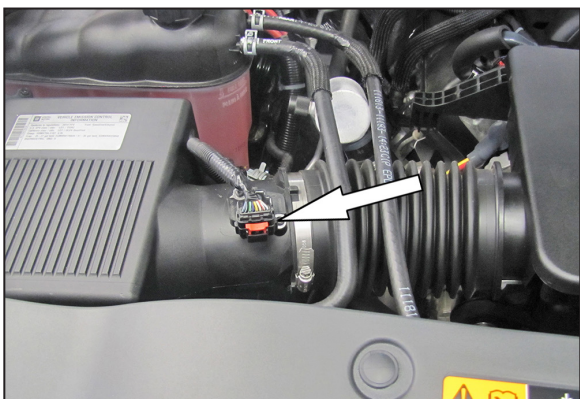

2. Disconnect the mass air sensor electrical connection and unhook the wiring harness from the air filter housing.

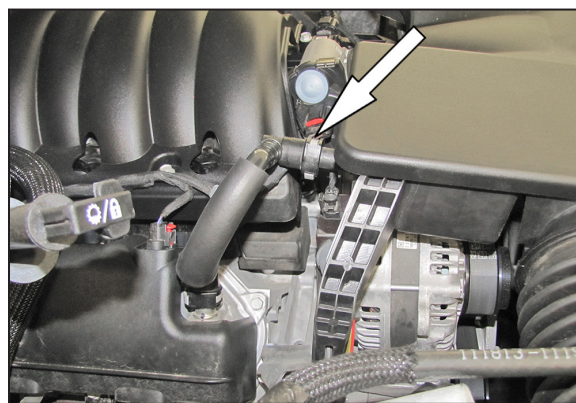

3. Disconnect the crank case vent from the intake plenum and valve cover port and remove it from the engine.

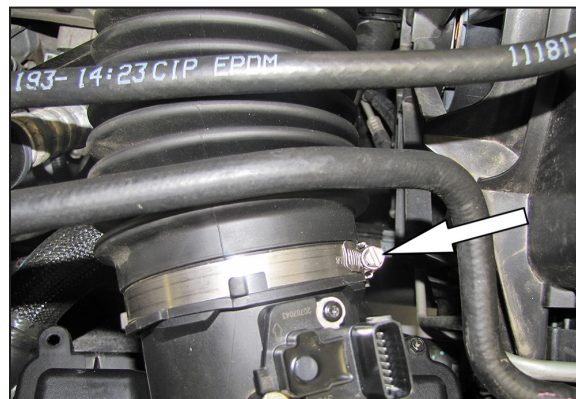

4. Loosen the hose clamp securing the intake tube to the air filter housing.

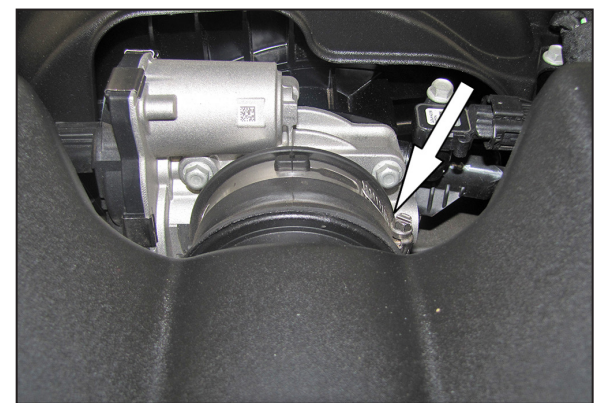

5. Loosen the hose clamp securing the intake plenum to the throttle body and then remove the intake plenum from the vehicle.



6. Lift up and remove the air filter housing from the vehicle.

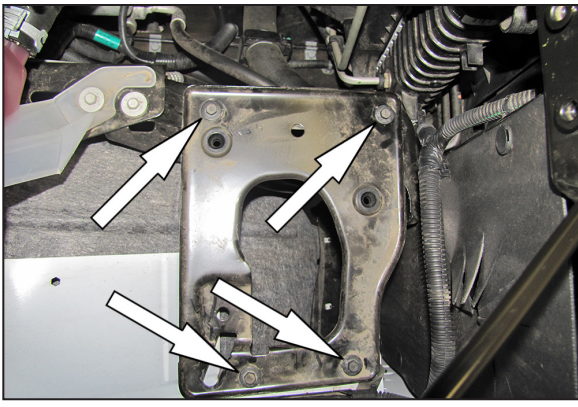

7. Remove the four bolts that secure the air filter housing mounting plate and then remove the plate from the vehicle.

NOTE: Three of the bolts will be reused in a later step.

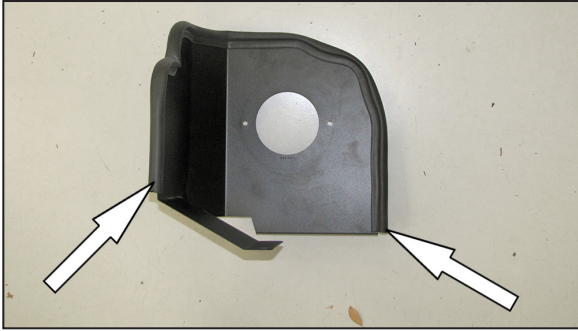

8. Install the provided edge trim onto the heat shield as shown.

NOTE: Some trimming of the edge trim will be necessary.

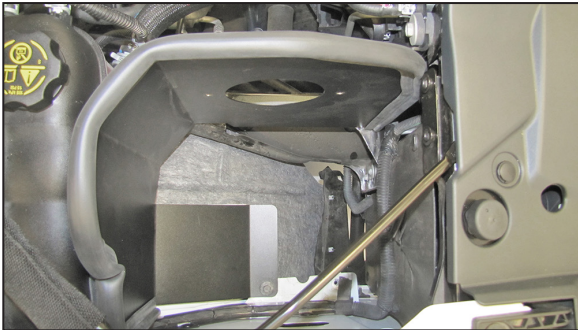

9. Install the heat shield and secure it to the air filter housing mounting plate location using three of the factory bolts from step #6.

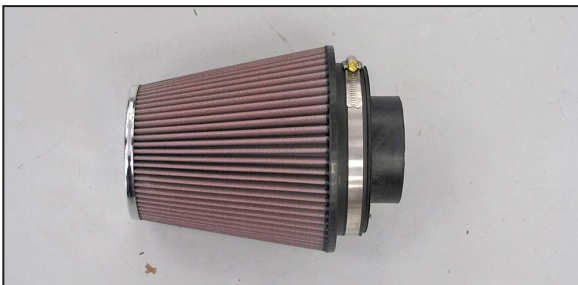

10. Install the filter adapter into the K&N® air filter and secure with the provided hose clamp.

NOTE: Drycharger® air filter wrap; part # RF-1041DK is available to purchase separately. To learn more about Drycharger® filter wraps or look up color availability please visit <http://www.knfilters.com>®.

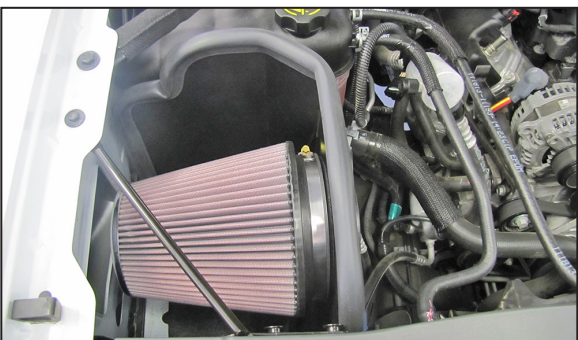

11. Install the filter assembly into the heat shield filter top first, then rotate the filter and pass the adapter through the hole in the heat shield. Secure the filter adapter to the heat shield using the provided hardware.

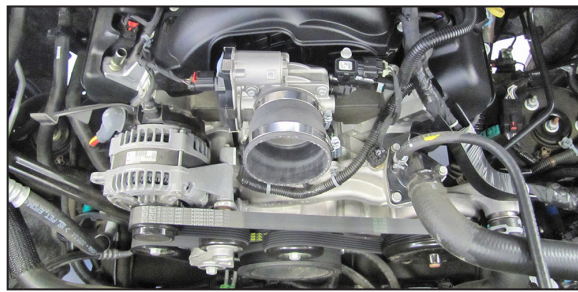

12. Install the provided step hose (084055) onto the throttle body and secure with the provided hose clamp.

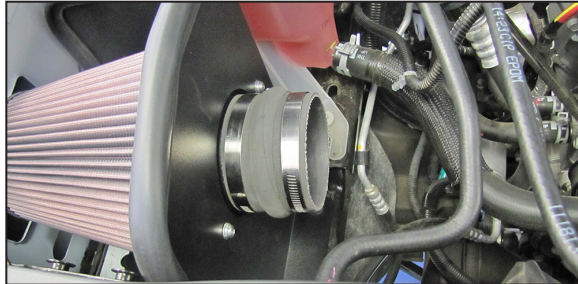

13. Install the provided hump hose (08699) onto the filter adapter and secure with the provided hose clamp.

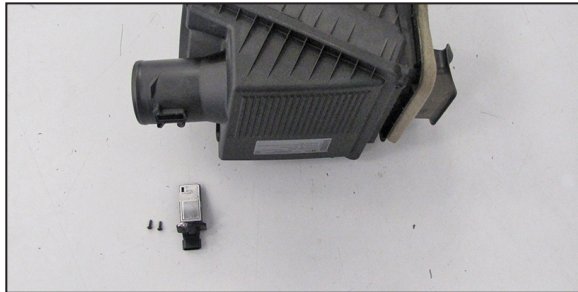

14. Remove the two screws securing the mass air sensor into the air filter housing and then remove the mass air sensor from the air filter housing.



15. Install the mass air sensor assembly into the K&N® intake tube and secure with the provided hardware.



16. Install the vent fitting into the K&N® intake tube. **NOTE:** Plastic NPT fittings are easy to cross thread. Install the vent fitting "hand" tight, then turn it two complete turns with a wrench.



17. Install the K&N® intake tube into the hose at the filter adapter and then into the hose at the throttle body. Adjust the tube for best fit and then secure with the provided hose clamps.

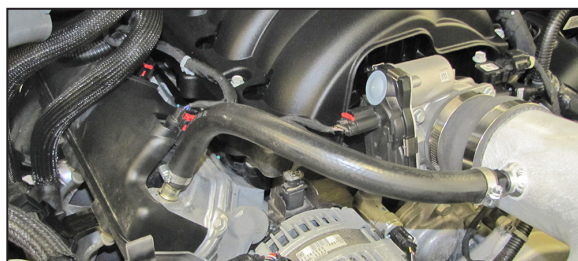

18. Install the provided crank case vent hose onto the valve cover port and onto the vent installed into the intake tube. Secure the hose with the provided hose clamps.

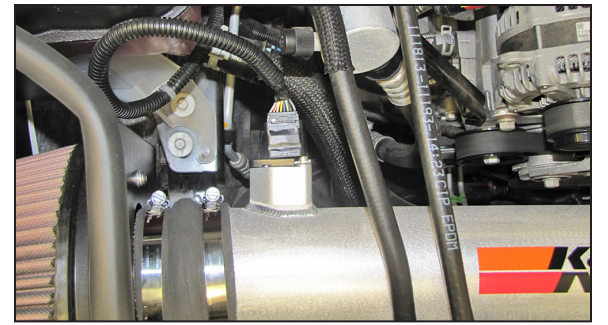

19. Reconnect the mass air sensor electrical connection.

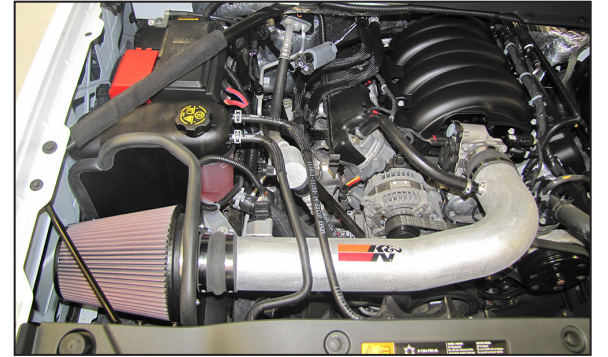

20. Reconnect the vehicle's negative battery cable. Double check to make sure everything is tight and properly positioned before starting the vehicle.

21. **NOTE:** Most General Motors vehicles have the Vehicle Emissions Certification Information (VECI) label affixed to the air filter box. In order to be compliant with California emissions laws, the label **MUST** remain in the engine compartment. If the Vehicle Emission Control Information label is removed during modification, a new replacement label must be obtained and installed in a readily visible position in the engine compartment. The label shall not be affixed to any equipment which is easily detached from the vehicle. We recommend that the label is affixed to the underside of the hood adjacent to the hood latch. The label is Vehicle Identification Number dependent and can be ordered from the vehicle dealership. In order to receive the proper decal please bring your VIN with you. Failure to have the VECI under the hood may result in failure of a pre-registration smog test.

22. It will be necessary for all K&N® high flow intake systems to be checked periodically for realignment, clearance and tightening of all connections. Failure to follow the above instructions or proper maintenance may void warranty.

ROAD TESTING:

1. Start the engine with the transmission in neutral or park, and the parking brake engaged. Listen for air leaks or odd noises. For air leaks secure hoses and connections. For odd noises, find cause and repair before proceeding. This kit will function identically to the factory system except for being louder and much more responsive.

2. Test drive the vehicle. Listen for odd noises or rattles and fix as necessary.

3. If road test is fine, you can now enjoy the added power and performance from your kit.

4. K&N Engineering, Inc., requires cleaning the intake system's air filter element every 100,000 miles. When used in dusty or off-road environments, our filters will require cleaning more often. We recommend that you visually inspect your filter once every 25,000 miles to determine if the screen is still visible. When the screen is no longer visible some place on the filter element, it is time to clean it. To clean and re-oil, purchase our filter Recharger® service kit, part number 99-5050 or 99-5000 and follow the easy instructions.

NOT LEGAL FOR SALE OR USE ON ANY POLLUTION CONTROLLED MOTOR VEHICLE IN CALIFORNIA OR STATES ADOPTING CALIFORNIA EMISSION PROCEDURES.

See knfilters.com for CARB status on each part for a specific vehicle