



SIGNATURE OF QUALITY

AUTOMOTIVE PRODUCTS, INC.

# INSTRUCTIONS—INSTRUCCIONES—CONSIGNES

**APPLICATION PART #:** 46-23685

2014-2015 CHEVY SILVERADO & GMC SIERRA 1500 WINCH TRAY

**APPLICATION PART #'S:** 45-93680, 40-93685, 57-93680, 57-93685

2014-2015 CHEVY SILVERADO 1500 SPORTSMAN & HDX

WINCH MOUNT GRILLE GUARDS

ITEM	QUANTITY	DESCRIPTION	TOOLS NEEDED
1	1	WINCH TRAY	RATCHET
2,3	2	WINCH TRAY MOUNTING BRACKETS (DRV & PASS)	SCREWDRIVER
4	2	M12 HEX BOLTS (LONG)	15MM WRENCH
5	4	M12 HEX BOLTS (SHORT)	15MM SOCKET
6	6	M12 FLAT WASHERS (NARROW)	ALLEN WRENCH
7	2	M12 FLAT WASHERS (THICK)	18MM WRENCH
8	2	M12 FLAT WASHERS (WIDE)	18MM SOCKET
9	6	M12 LOCK WASHERS	10MM SOCKET
10	4	M12 FLANGE BOLTS	7MM SOCKET
11	4	M12 SERRATED FLANGE NUTS	16MM SOCKET
12	2	M12 HEX NUTS	16MM WRENCH
13	2	M10 FLANGE BOLTS	RATCHET EXT.
14	2	M10 SERRATED FLANGE NUTS	TORQUE WRENCH
15	1	HDX GRILLE GUARD (57-93680, 57-93685 ONLY)	UTILITY KNIFE
16	1	SPORTSMAN GRILLE GUARD (45-93680, 40-93685 ONLY)	
17,18	8	UPPER SUPPORT STRAPS (57-93680/85, 45-93680, 40-93685 ONLY)	
19	2	SPACER BRACKETS (57-93680/85, 45-93680, 40-93685 ONLY)	
20	2	M10 BUTTON HEAD BOLT (57-93680/85, 45-93680, 40-93685 ONLY)	
21	4	M10 FLAT WASHER (57-93680/85, 45-93680, 40-93685 ONLY)	
22	2	M10 LOCK WASHER (57-93680/85, 45-93680, 40-93685 ONLY)	
23	2	M10 HEX NUT (57-93680/85, 45-93680, 40-93685 ONLY)	
24	4	M12 BUTTON HEAD BOLT (57-93680/85, 45-93680, 40-93685 ONLY)	
25	4	M12 FLAT WASHER (57-93680/85, 45-93680, 40-93685 ONLY)	
26	8	M12 FLANGE NUT (57-93680/85, 45-93680, 40-93685 ONLY)	
27	4	M12 FLANGE BOLT (57-93680/85, 45-93680, 40-93685 ONLY)	

## ANTI-SEIZE LUBRICANT MUST BE USED ON ALL STAINLESS STEEL FASTENERS TO PREVENT THREAD DAMAGE AND GALLING

1. Remove contents from box, verify if all parts listed are present and free from damage. Carefully read and understand all instructions before attempting installation. **Failure to identify damage before installation could lead to a rejection of any claim.**
2. Remove the filler panel from the front of the vehicle (Figures 1-4).
3. If installing a Winch Mounted Grille Guard kit remove the vehicle's grille (Figures 5 - 6). Skip this step if installing kit 46-23685.



Westin Automotive Products, Inc.  
320 Covina Blvd  
San Dimas, Ca. 91773

Thank you for choosing Westin products  
for additional installation assistance please call  
Customer Service (800) 793-7846  
www.westinautomotive.com

Pull up all fasteners and re-  
move plastic radiator cover.

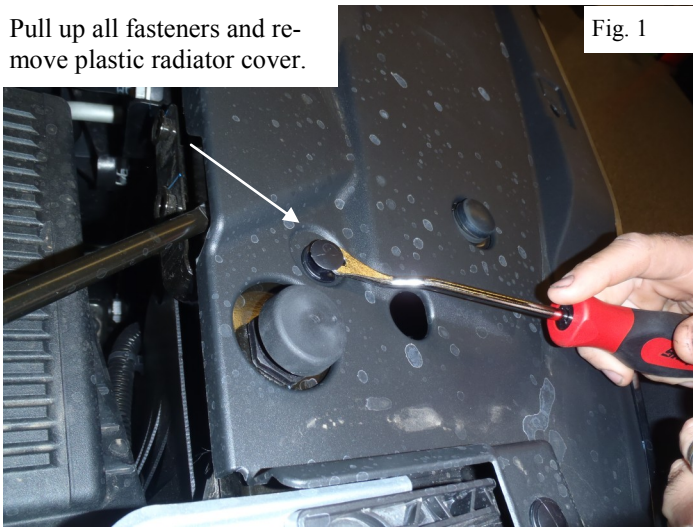
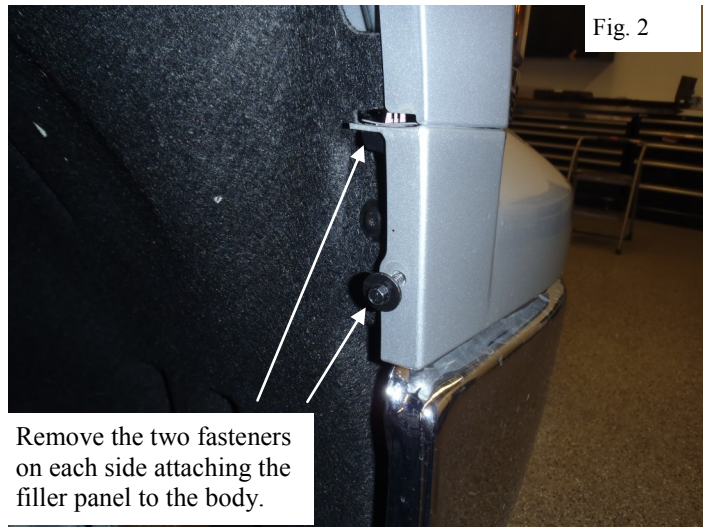

Fig. 1

Fig. 2



Remove the two fasteners  
on each side attaching the  
filler panel to the body.

Working from beneath the vehicle use a flathead  
screwdriver to pop loose the plastic tabs retain-  
ing the filler panel to the grille.

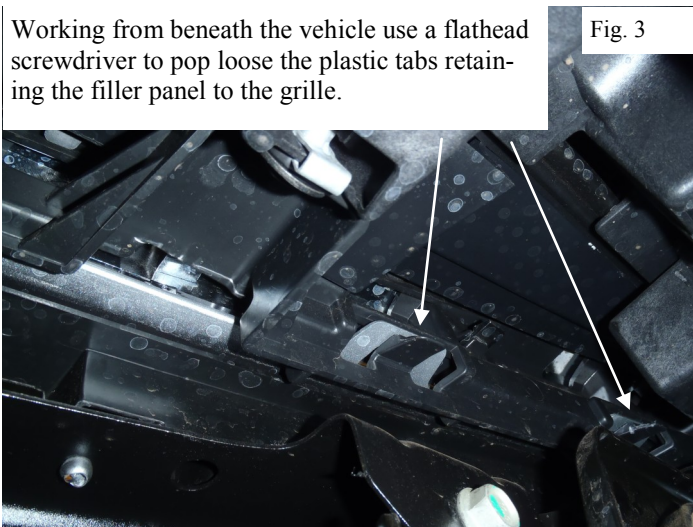

Fig. 3

Once all fasteners have been removed  
and the tabs are popped loose carefully  
pull the filler panel off of the vehicle.



Fig. 4

Remove all of the lower  
screws holding the grille to  
the radiator support.

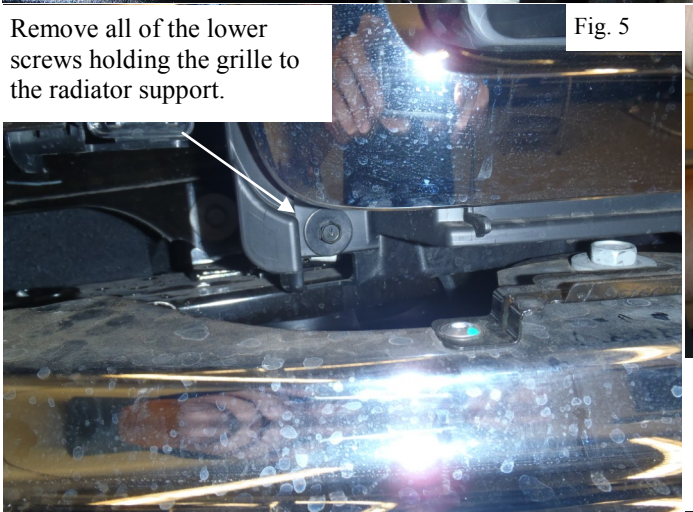

Fig. 5

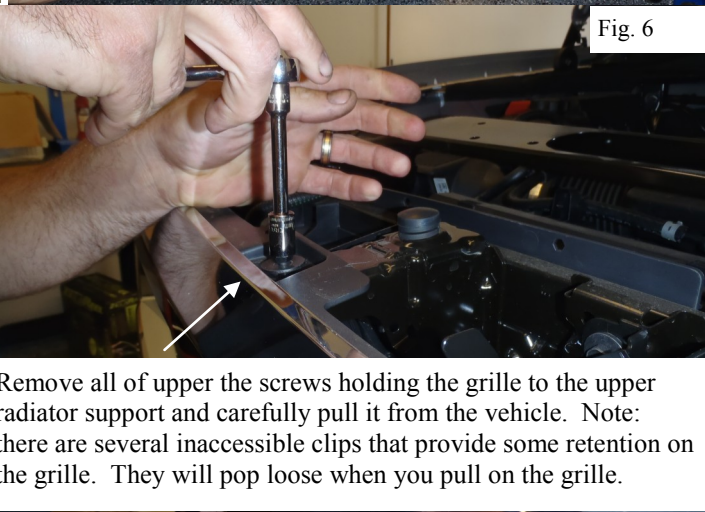

Fig. 6

Remove all of upper the screws holding the grille to the upper  
radiator support and carefully pull it from the vehicle. Note:  
there are several inaccessible clips that provide some retention  
on the grille. They will pop loose when you pull on the grille.

4. Remove the front bumper assembly (Figures 7 & 8).
5. If equipped, remove the factory tow hooks and foam tow hook covers (Figures 9 & 10).



Westin Automotive Products, Inc.  
320 Covina Blvd  
San Dimas, Ca. 91773

Thank you for choosing Westin products  
for additional installation assistance please call  
Customer Service (800) 793-7846  
www.westinautomotive.com



Remove this M10 bolt from each side of the bumper (Driver side shown).

Fig. 7



Remove these M12 bolts from each side of the bumper (Driver side shown).

Fig. 8

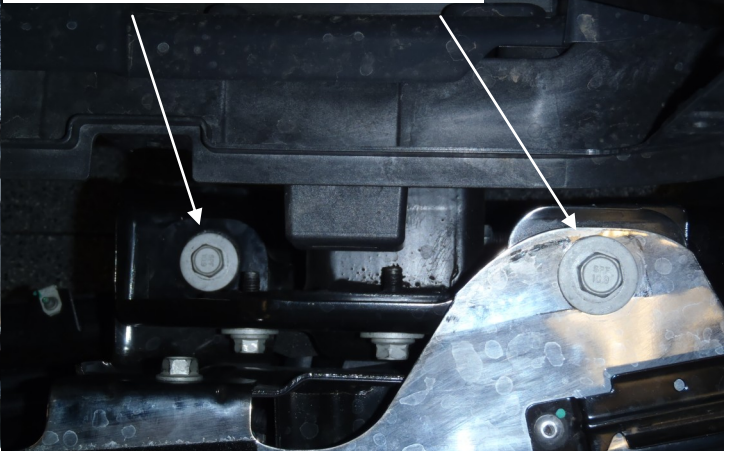

Loosen the (3) bumper bracket bolts on the Driver Side only.

Fig. 9

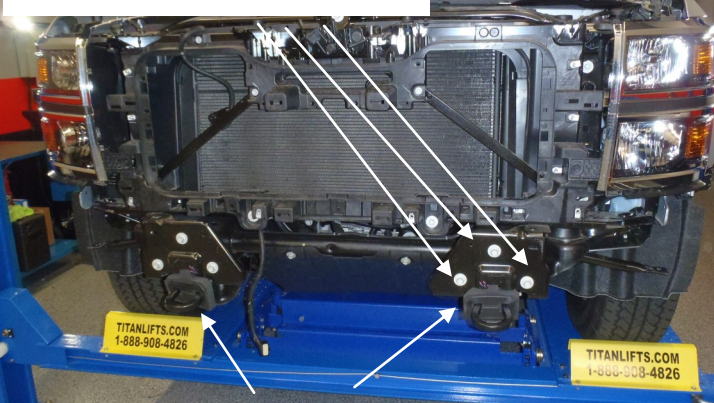

Remove and discard the foam tow hook covers.



Fig. 10

Remove the two tow hook bolts on each side of the vehicle then pull out the tow hooks.

6. Slip the supplied winch tray mounting brackets into the frame rails and loosely secure them with the supplied M12 hardware (Figures 11 & 12). Note: The thick M12 washers are placed inside the large holes in the bottom of the frame then secured in place with the wide M12 washers, lock washers and hex bolts.

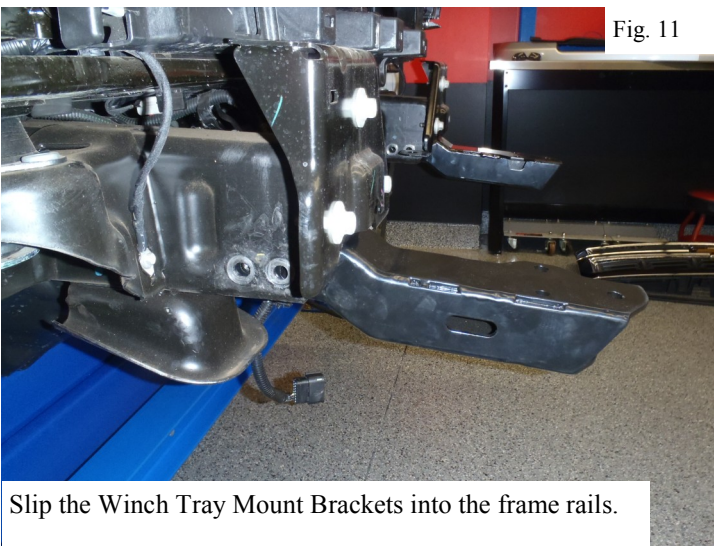

Fig. 11

Slip the Winch Tray Mount Brackets into the frame rails.

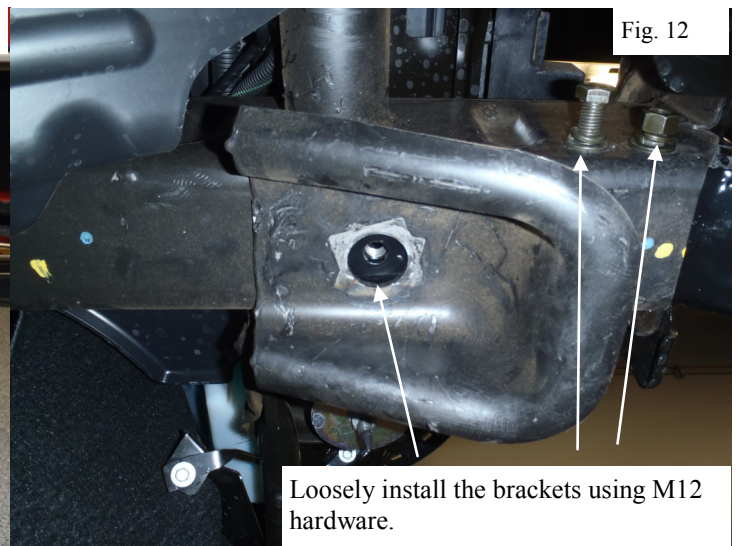

Fig. 12

Loosely install the brackets using M12 hardware.



Westin Automotive Products, Inc.  
320 Covina Blvd  
San Dimas, Ca. 91773

Thank you for choosing Westin products  
for additional installation assistance please call  
Customer Service (800) 793-7846

[www.westinautomotive.com](http://www.westinautomotive.com)



7. Re-install the bumper in the reverse order that it was removed. Note: For Chevy vehicles without factory tow hooks and all GMC vehicles, tow hook pocket trimming will be required to accomplish this step.
8. Loosely install the Winch Tray to the mounting brackets using the supplied M10 and M12 hardware (Figure 13).
9. Tighten and torque M10 hardware to 30—35 ft-lbs, M12 to 50—55 ft-lbs.
10. If installing a Winch Tray Mounted Grille Guard, loosely attach the square Spacer Brackets to the ends of the Winch Tray using M12 flange bolts and nuts.

Use M12 hardware in these holes.

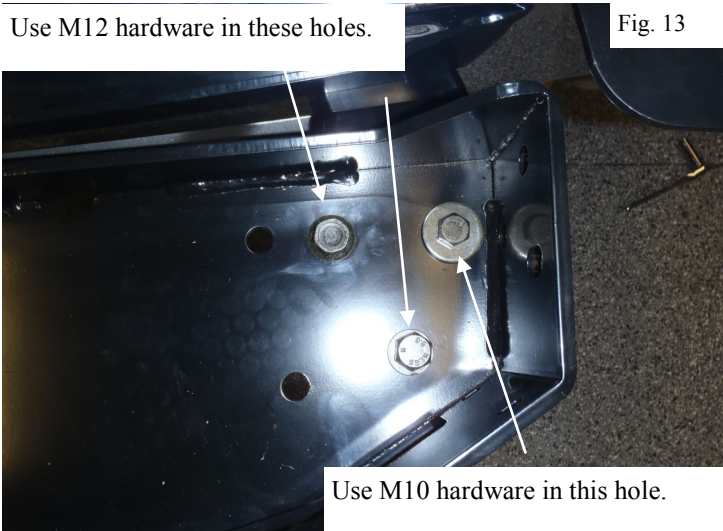

Fig. 13

Install the Upper Support Strap as shown.

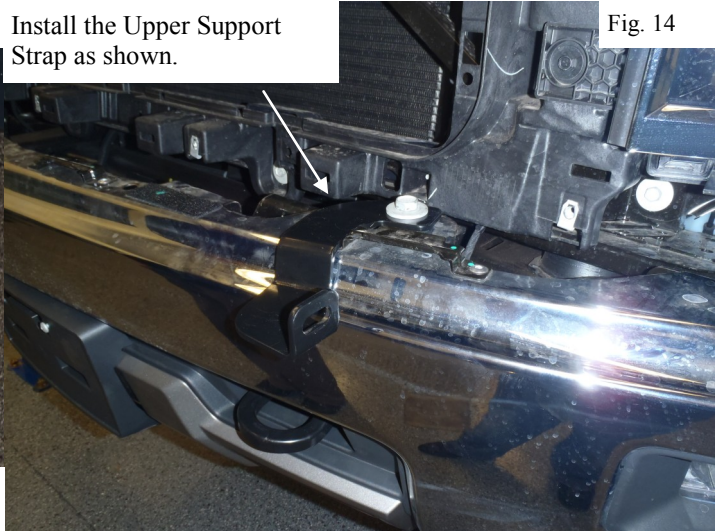

Fig. 14

11. Remove the upper factory bumper bolts and re-use them to install the Upper Support Straps. Adjust the Upper Support Straps so that they are approximately 20-5/8" from the center of the bumper then torque the factory bumper bolts to 50-55 ft-lbs. (Figures 14 & 15).

Adjust to 20-5/8" from center of bumper to edge of Upper Support

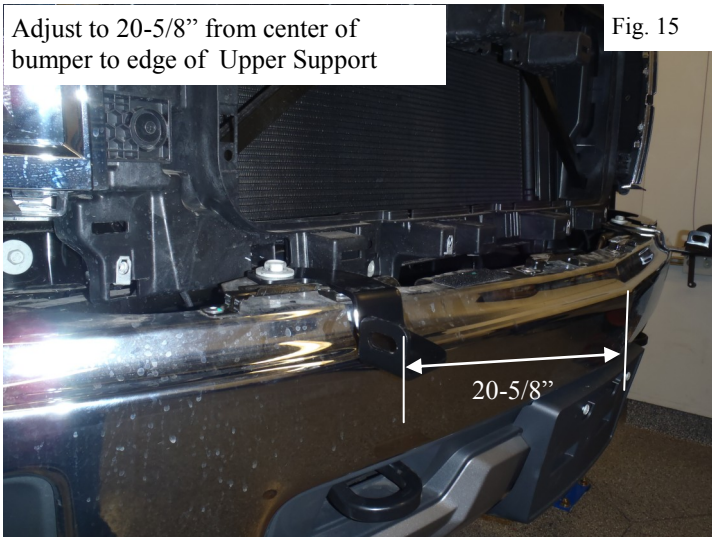

Fig. 15

Attach the Grille Guard to the Upper Support Strap using M10 Button Head hardware.

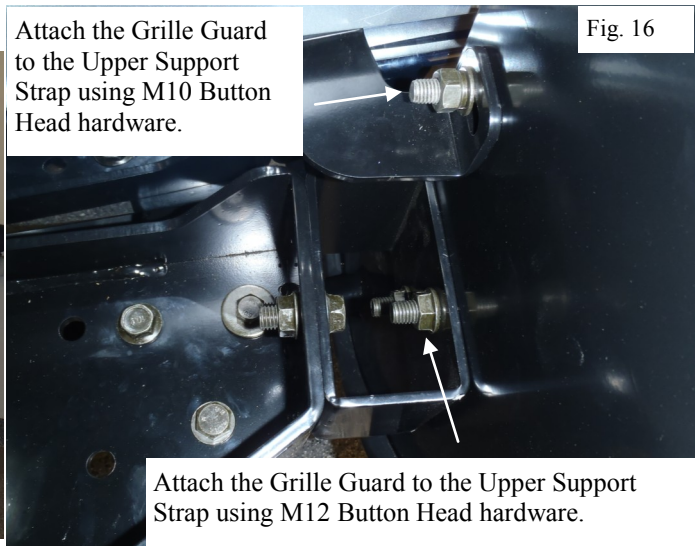

Fig. 16

Attach the Grille Guard to the Upper Support Strap using M12 Button Head hardware.

12. Re-install the vehicle's filler panel and grille in the opposite order that they were removed.
13. Install the winch per the winch manufacturer's instructions. Note: Many winches cannot be installed once the grille guard has been bolted in place.
14. With assistance loosely install the Grille Guard on the previously installed Spacer Brackets using the supplied M12 Button Head Bolts (Figure 16).
15. Loosely bolt the Upper Support Strap to the Grille Guard using the supplied M10 hardware (Figure 16).



Westin Automotive Products, Inc.  
320 Covina Blvd  
San Dimas, Ca. 91773

Thank you for choosing Westin products  
for additional installation assistance please call  
Customer Service (800) 793-7846  
www.westinautomotive.com

Sportsman Winch GG Installation Complete



HDX Winch GG Installation Complete



12. Align and adjust the Grille Guard as necessary. Tighten all remaining hardware; M10 to 30-35 ft-lbs., M12 to 50-55 ft-lbs.

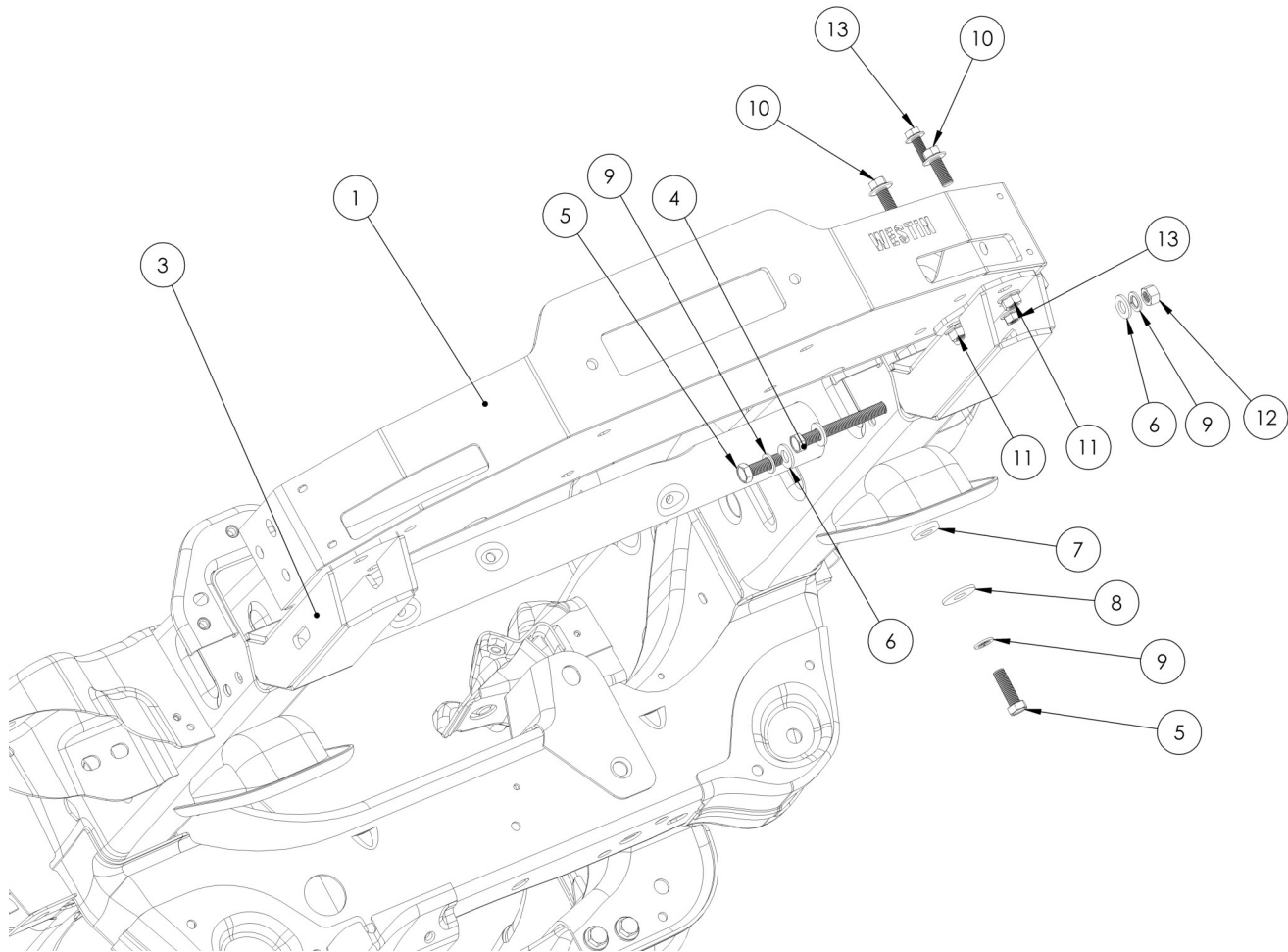

WINCH TRAY MOUNTING EXPLODED VIEW



Westin Automotive Products, Inc.  
320 Covina Blvd  
San Dimas, Ca. 91773

Thank you for choosing Westin products  
for additional installation assistance please call  
Customer Service (800) 793-7846  
www.westinautomotive.com



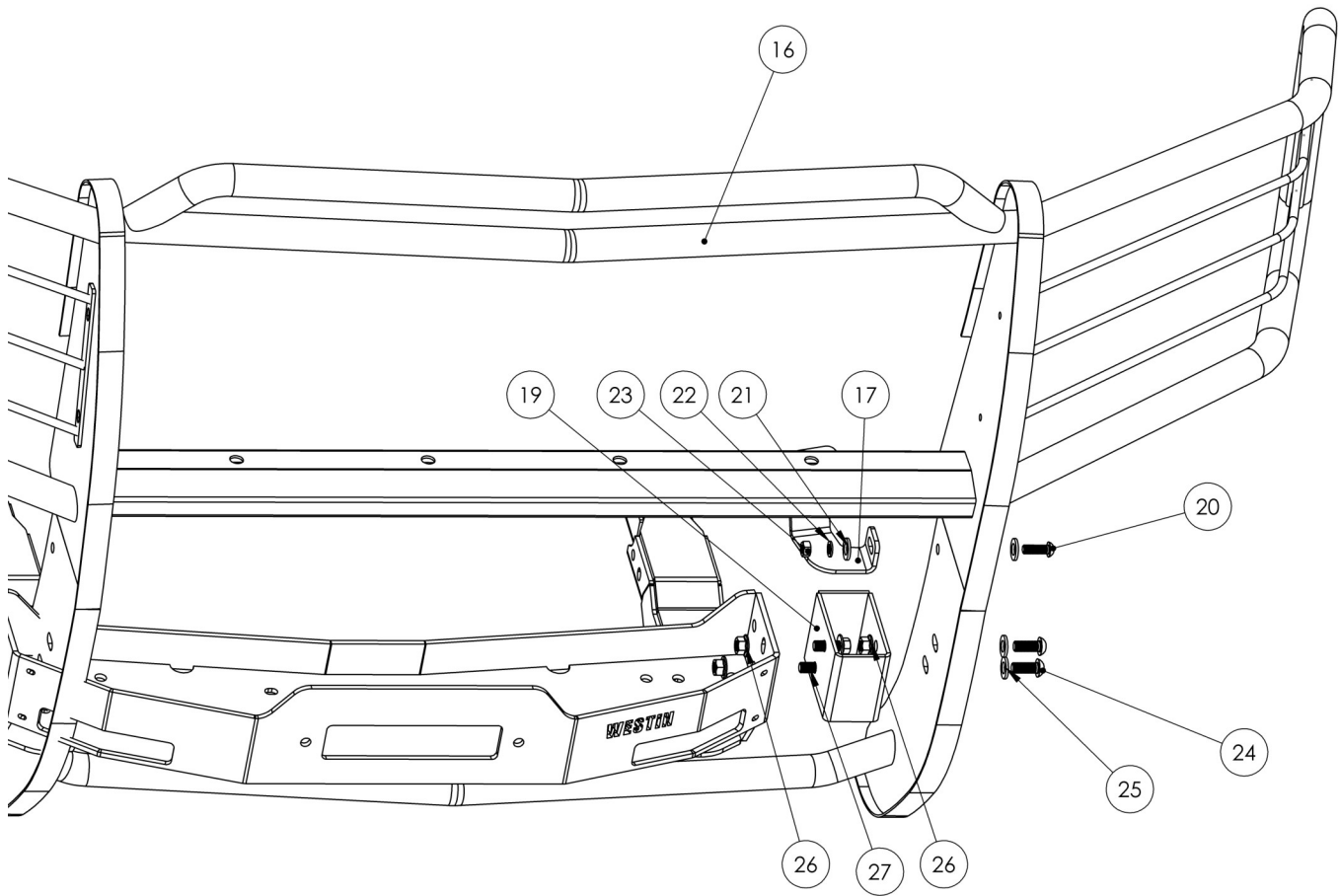

WINCH TRAY MOUNTED SPORTSMAN EXPLODED VIEW (HDX SIMILAR)

**CARE INSTRUCTIONS**

- REGULAR WAXING IS RECOMMENDED. DO NOT USE ANY TYPE OF POLISH OR WAX THAT MAY CONTAIN ABRASIVES
- STAINLESS STEEL PRODUCTS CAN BE CLEANED WITH MILD SOAP AND WATER. STAINLESS STEEL POLISH SHOULD BE USED TO POLISH SMALL SCRATCHES.
- GLOSS BLACK FINISHES SHOULD BE CLEANED WITH MILD SOAP AND WATER



Westin Automotive Products, Inc.  
320 Covina Blvd  
San Dimas, Ca. 91773

Thank you for choosing Westin products  
for additional installation assistance please call  
Customer Service (800) 793-7846  
[www.westinautomotive.com](http://www.westinautomotive.com)