



2015-16 4WD GM 1500 Denali w/ MagneRide 7" Bracket Kit w/ Aluminum Control Arms

Thank you for choosing Rough Country for your suspension needs.

Rough Country recommends a certified technician install this system. In addition to these instructions, professional knowledge of disassemble/reassembly procedures as well as post installation checks must be known. Attempts to install this system without this knowledge and expertise may jeopardize the integrity and/or operating safety of the vehicle.

Please read instructions before beginning installation. Check the kit hardware against the parts list on the rear cover of these instructions. Be sure you have all needed parts and know where they go. Also please review tools needed list and make sure you have needed tools.

PRODUCT USE INFORMATION

▲WARNING The taller a vehicle is, the easier it will roll. Seat belts and shoulder harnesses should be worn at all times. Avoid situations where a side rollover may occur. Generally, braking performance and capability are decreased when larger/heavier tires and wheels are used. Take this into consideration while driving. Do not add, alter, or fabricate any factory or after-market parts to increase vehicle height over the intended height of the Rough Country product purchased. Mixing component brands is not recommended.

▲WARNING Rough Country makes no claims regarding lifting devices and excludes any and all implied claims. We will not be responsible for any product that is altered. If question exist we will be happy to answer any questions concerning the design, function, and correct use of our products.

▲WARNING The electric power steering must be unplugged before any of the steering components are removed. Failure to do so may cause damage to the electric power steering.

▲WARNING Trucks equipped with a mass damper on the front diff, the damper will have to be removed.

This kit is packaged as a leveling kit- raising the front 7+and the back 5.25+ If you desire a different look or if the vehicle has a tool box or added weight in the rear, please consult with your sales representative about other block and u-bolts.

This suspension system was developed using a 35+x 12.5+tire with 20+x 9+wheel and a offset of . 12mm to +18mm.

Note if wider tires are used, offset wheels will be required and trimming may be required.

▲WARNING DEALER AND VEHICLE OWNER

Any vehicle equipped with any Rough Country product should have a %Warning to Driver+decal installed on the inside of the windshield or on the vehicles dash. The decal should act as a constant reminder for whoever is operating the vehicle.

Tools Needed:

Floor Jack /Jack Stands	#30 Torx bit
8mm Allen Socket	Reciprocating Saw
10mm socket /wrench	Drill
11mm socket /wrench	9/16+Drill Bit
13 mm socket/wrench	3+Hole Saw
15mm socket / wrench	Hand Grinder
17mm socket/wrench	
18mm socket /wrench	
21mm socket /wrench	
22mm socket /wrench	
24mm socket /wrench	
19mm socket /wrench	
35mm socket	
1/2+socket/wrench	
9/16+socket /wrench	

Torque Specs:

Size	Grade 5	Grade 8
5/16+	15 ft/lbs	20 ft/lbs
3/8+	30 ft/lbs	35 ft/lbs
7/16+	45 ft/lbs	60 ft/lbs
1/2+	65 ft/lbs	90 ft/lbs
9/16+	95 ft/lbs	130 ft/lbs
5/8+	135 ft/lbs	175 ft/lbs
3/4+	185 ft/lbs	280 ft/lbs
	Class 8.8	Class 10.9
6MM	5 ft/lbs	9 ft/lbs
8MM	18ft/lbs	23 ft/lbs
10MM	32ft/lbs	45ft/lbs
12MM	55ft/lbs	75ft/lbs
14MM	85ft/lbs	120ft/lbs
16MM	130ft/lbs	165ft/lbs
18MM	170ft/lbs	240ft/lbs

KIT CONTENT



Thank you for choosing Rough Country for your suspension needs.



Box Kit

1290Box1

Front Cross Member-1
Rear Cross Member-1
12090Bag1-1

1290Box2

Upper Control Arm Drop Driver-1
Upper Control Arm Drop Passenger-1
Diff Drop Driver-1
Diff Drop Passenger-1
Front Upper Arm Driver Brace-1
Front Upper Arm Passenger Brace-1
Rear Upper Arm Driver Brace-1
Rear Upper Arm Passenger Brace-1
Steering Extension Bracket-1
E-brake Bracket-1
Rear Brake Line Bracket-1
1290Bag2-1
1290Bag3-1
1290Bag4-1
1290Bag5-1
1290Bag6-1
1290Bag9-1

1290Box3

Lower Skid Plate-1
1290Bag7-1

1290Box4

Front Skid Plate-1

176Box1

Upper Strut Spacers-2
Lower Strut Spacers-2
10mmstudbag-1
9/16Bag-1
1263Bag2-1
Fabbed Rear Block-2
U-bolts-4
Rear Shock Relocation Brackets-2
1290Bag8-1

Kit Bags

1290Bag1

5/8+x 5+Bolts-2
5/8+Washers-8
5/8+Nylock Nuts-4
5/8+x 5.5+Bolts-2

1291Bag2

2014 GM Steering Extension-1

1291Bag3

1/4+x 3/8+Set Screw-1
3/4+Metal Race Hiems Joint-1

1290Bag4

3/8+x 1.25+Bolts-14
3/8+Lock Washers-14
3/8+Nuts-14
9/16+x 4+Bolts-4
9/16+Nylock Nuts-4

1290Bag5

12mm x 140mm Bolt-1
1/2+Washer-5
12mm Flange Nut-5
1/4+Vent Hose-1
1/4+Coupler-1
12mm x 45mm Bolts-4

1290Bag6

10mm x 35mm Bolts-4
10mm Nylock Nuts-4
3/8+Washers-4
5/16+x 1+Bolts-5
5/16+Toplock Nuts-5
5/16qWashers-10

1290Bag7

3/8+1.25+Bolts-8
3/8+Washers-8

1298Bag1

Instruction Sheet-1
Shock Stickers-2
Warning to Driver Sticker-1

1290Bag9

Cam Bolt Block Off Plates-6
Block Off Plate With ABS Mount-2
Rack And Pinion Shims-2

1290Bag10

18mm-2.5 x 150mm Bolt-1
18mm Lock Nut-1
3/4+Washer-1

1308Bag

10mm x 90mm Bolts-4
10mm Nylocks-4
10mm Washers-8

183Bag2

14mm x 85mm Bolts-2
14mm Nylock Nuts-2
1/2+x 1.5+Bolts-2
1/2+Washers-2
9/16+Washers-4
Magneride Shock Brckt Washers-2

FRONT INSTALLATION

1. Park the vehicle on a level surface and chock the rear wheels. Raise the hood and disconnect the battery using a 10mm socket. Lock the steering wheel in the straight position.
2. Jack up the front of the vehicle. Place jack stands under the frame rails and lower onto jack stands letting the front suspension hang.
3. Remove the tires and wheels. Remove the 6 bolts holding the factory skid plate using a 15mm socket. Unplug the two connectors going to the electric power steering wiring harness behind the front skid plate. **See Photo 1.**
4. Remove and unplug the ABS sensor wire from the frame as shown in **Photo 2.**

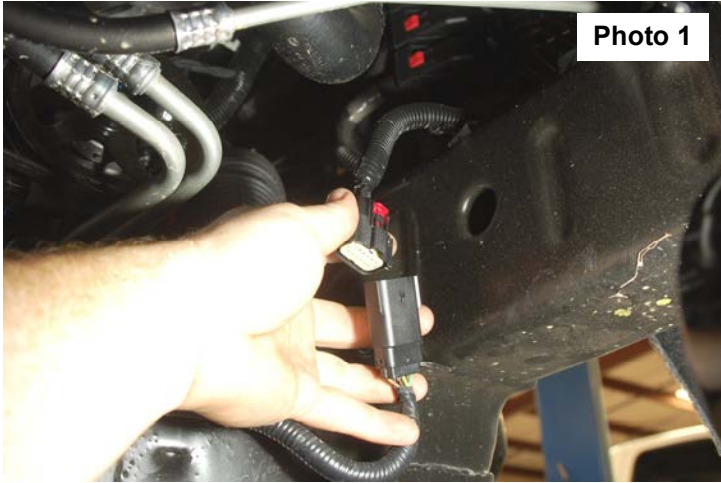

5. Remove the sensor wire from the plastic clip. Remove the brake line bracket from the control arm using a 10mm wrench. **See Photo 3.** Next remove the bracket line bracket from the control arm pocket with a 13mm wrench.
6. Using a 21mm wrench, remove the tie-rod nut as shown in **Photo 2.** Strike the front of the mount to dislodge the tie rod end. Remove from the knuckle.

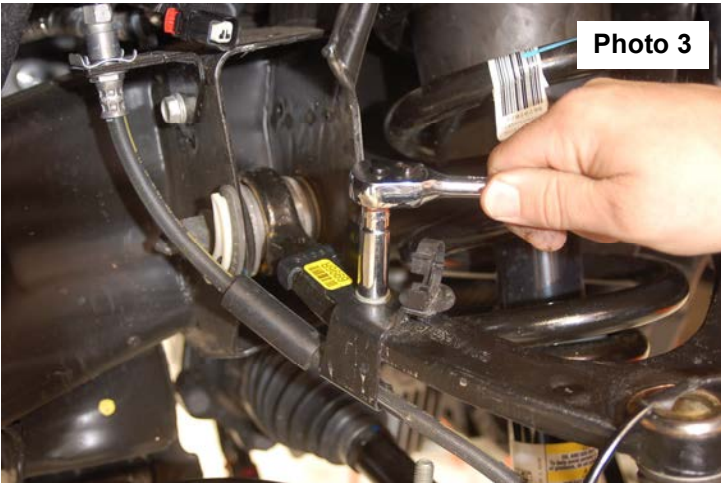

7. Remove the brake caliper using a 18mm socket. Hang the caliper out of the way and remove the rotor using a 30 torx socket. **See Photo 5.**
8. Use a 10mm socket to remove the brake line bracket from the knuckle.
9. Remove the dust cap and then remove the axle nut using a 35mm socket.

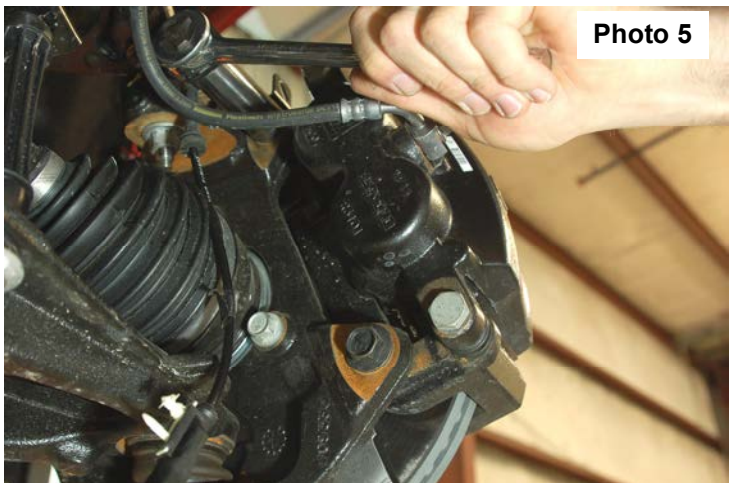

10. Remove the upper ball joint using a 18mm socket and separate using a hammer and striking the knuckle on the side as shown in **Photo 6**.
11. Remove the lower ball joint using a 24mm socket and separate with a hammer as shown in **Photo 7**. Next remove the knuckle from the truck.

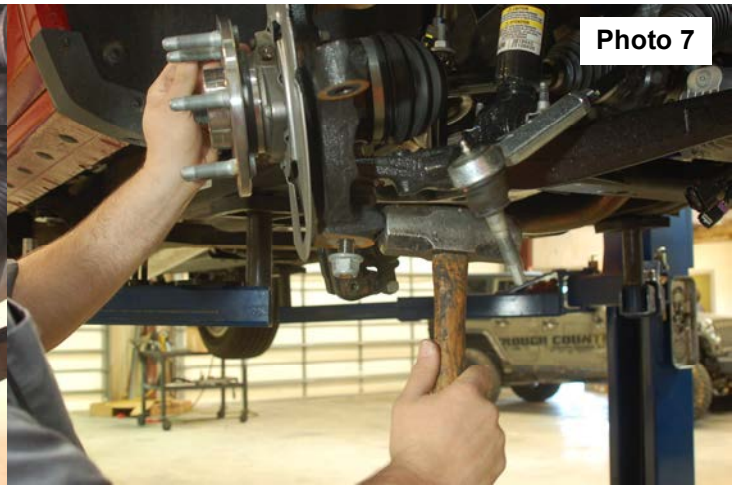
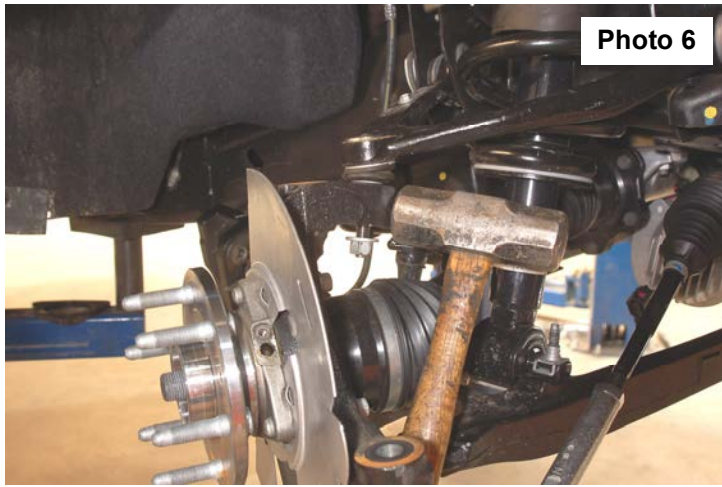

12. Using a 15mm wrench and socket remove the sway bar links from the truck. **See Photo 8**.
13. Remove the lower strut bolts using a 15mm socket as shown in **Photo 9** and remove the upper strut nuts using a 18mm wrench. Remove the strut from the truck.

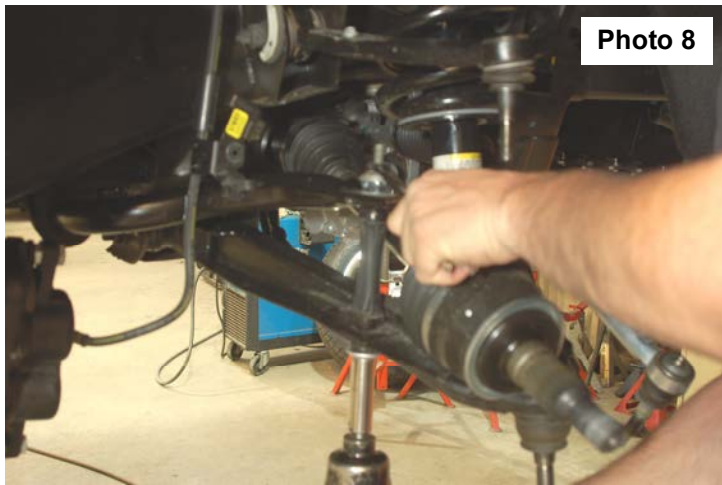

14. Remove CV axle bolts using a 15mm socket. **See Photo 10**.
15. Using a 10mm socket remove the sway bar from the bottom of the frame. **See Photo 11**.



16. Remove the lower control arm using a 18mm wrench and a 24mm socket. **See Photo 12.**
17. Make sure the steering wheel is straight, mark the intermediate shaft and the rack and pinion as shown in **Photo 13.**

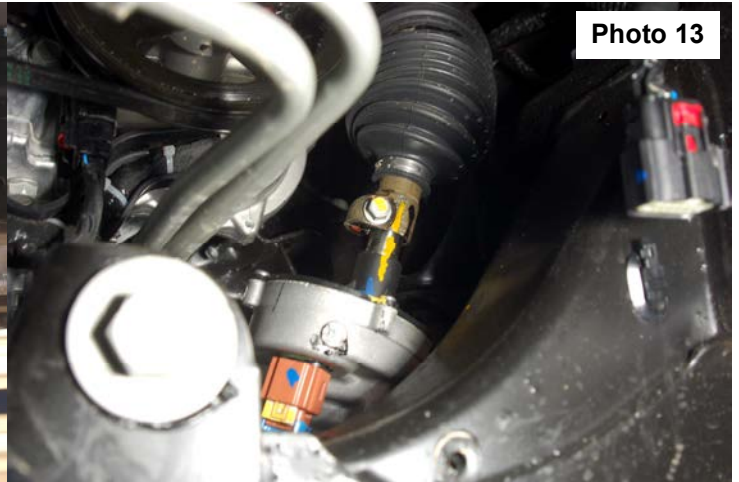

18. Using a 11mm socket, remove the bolt in the intermediate shaft. **See Photo 14.**
19. Support the rack and pinion with a jack and take good care not to hit or drop the rack. Use a 24mm socket and a 18mm socket to remove the bolts from the rack and pinion. Carefully lower rack and pinion down making sure no wires are in harms way. Place the rack and pinion in a safe secure area. **See Photo 15.**

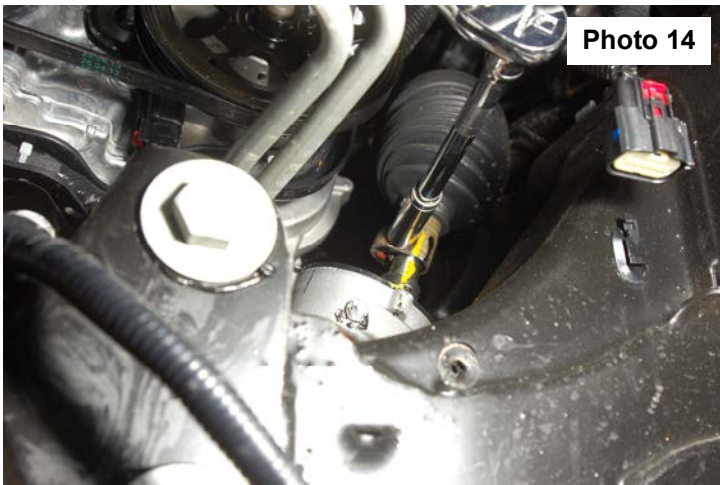

20. Using a 18mm wrench and socket remove the factory lower rear cross-member. **See Photo 16.**
21. Using a 11mm socket remove the driveshaft from the front diff . **See Photo 17.** Unplug the actuator wire from diff. remove wire loom from diff. remove vent tube from diff.

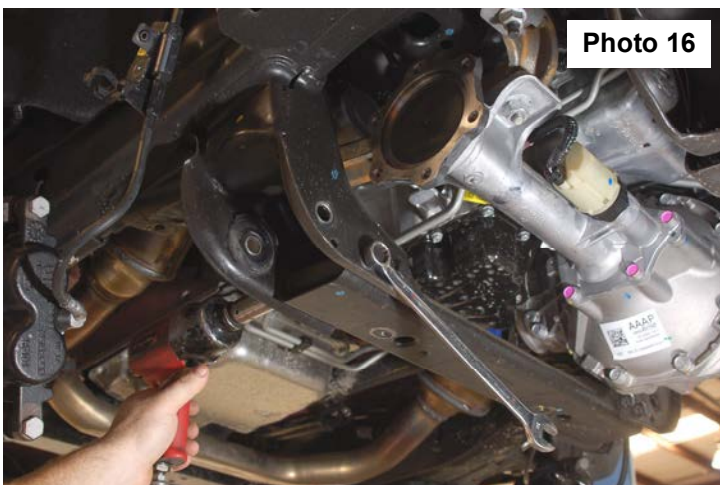

22. Support diff. Using a 18mm socket and 21mm socket remove the bolts from diff. lower diff from truck. **See Photo 18.**
23. Mark the front and rear sides of the driver's side rear control arm pocket, measure 3 3/8" and cut rear lower control arm pocket. **See Photo 19.**



Photo 18



Photo 19

24. Cut and remove the skid plate bracket from the front factory cross-member. Cut the corners out of both front lower control arm pockets. **See Photo 20.**
25. Cut the upper control arm bump stop out as shown in **Photo 21.**

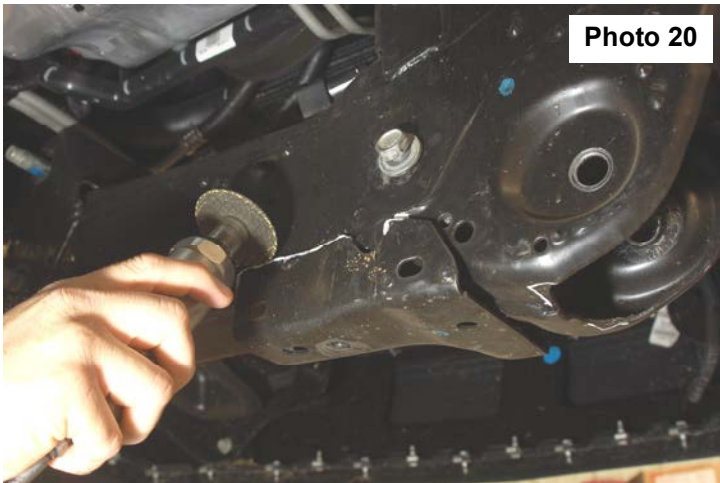

Photo 20

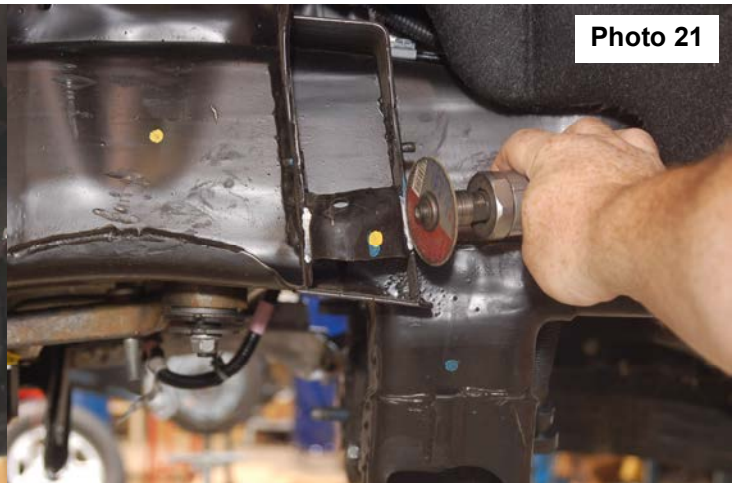

Photo 21

26. Then measure 1 5/8" from the cam bolt pin down and mark both side of the front control arm pocket this is your cut line. Cut straight back to frame then straight down against frame. Clean and paint all cut areas. **See Photo 22.**
27. Using template on passenger side of truck mark and drill the hole to a 9/16". this hole is for the rack and pinion mount. then on driver side using the template mark and cut the area using a 3 inch hole saw. **See Photo 23.**

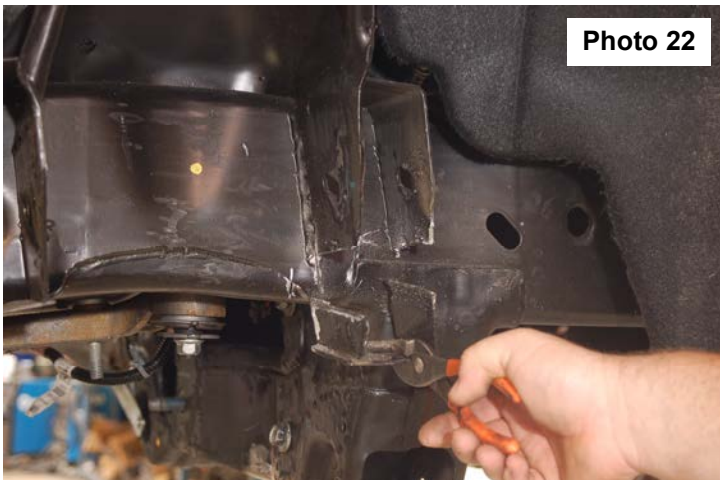

Photo 22

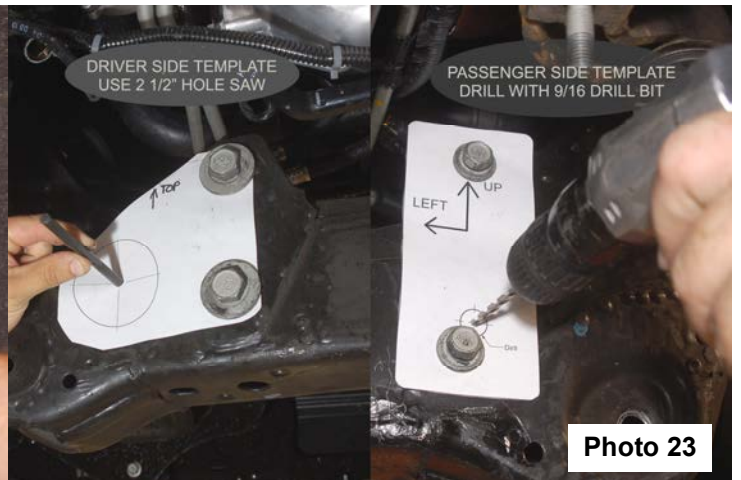

Photo 23

28. Install the hiems joint into the steering bracket and adjust the length to 3+ from the back of the threaded tube to the center of the center of the ball. Use supplied set screw to lock the hiems into place. **See Photo 24.**
29. Install the 18mm x 150mm bolt, washer, and nut in the top mounting hole and factory bolt on lower hole. **See Photo 25.**

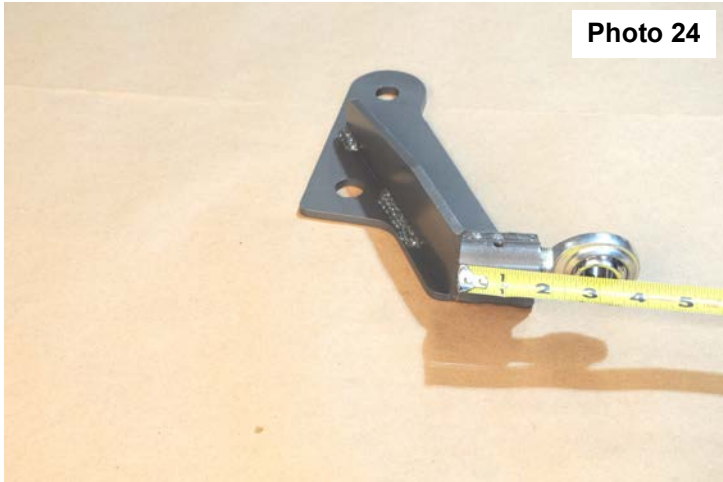

Photo 24

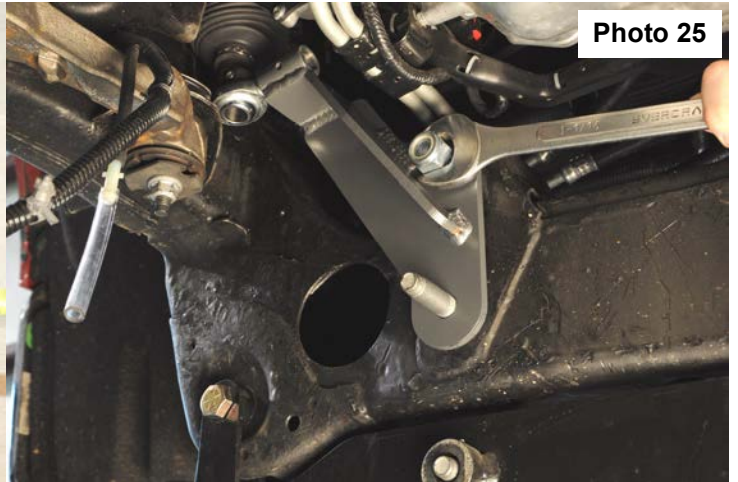

Photo 25

30. Install the steering extension through the 3/4 hiems and slide the stock steering shaft onto the steering extension. Lock into place using the factory bolt. **See Photo 26.**
31. Install both upper control arm support brackets onto upper control arm drops brackets using 3/8+x 1.25+bolt, washers, lock washers, and nuts but do not tighten at this time. **See Photo 27 & 28.** Make sure the flag nut is used for the bolts on the rear of the control arm drop bracket. Also the lock washer will go on the head side of the flag nut bolts.

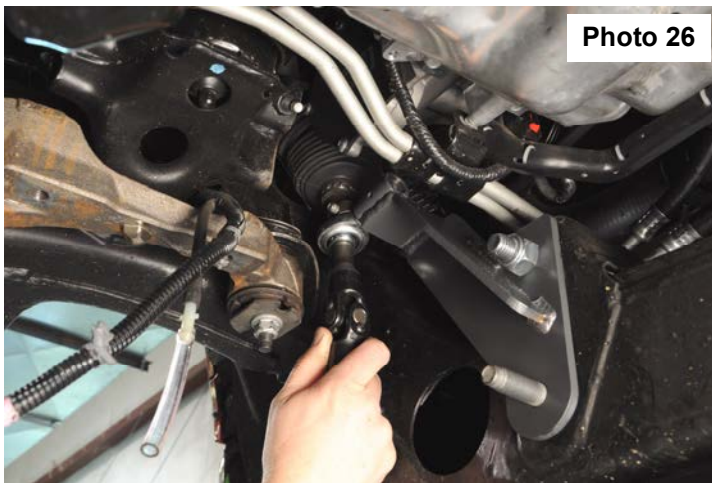

Photo 26

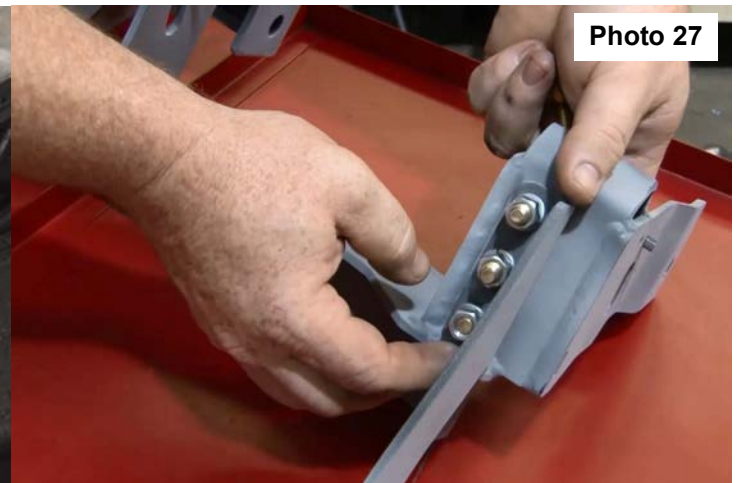

Photo 27

32. Install upper control arm drops onto truck using supplied 9/16+x 4+bolts and nuts using four cam lock washer per side with one cam lock washer with a tail on the back side for the ABS wire. **See Photo 29.**



Photo 28



Photo 29

33. Install the front cross-member using the supplied 5/8"x 5.0"+bolts, washers, nut. Bolt must be install from back to front. **See Photo 30.**

34. Install rack and pinion using stock bolts on driver side and one stock and one new on passenger side 12mm x 140mm bolt and washer. Slide steering extension onto rack and pinion steering stud as you are installing it. **See Photo 31.**



Photo 30

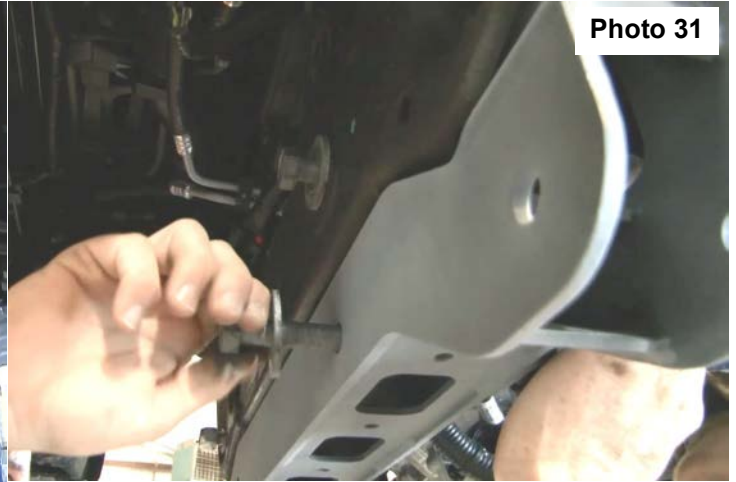

Photo 31

35. Install the rack and pinion spacer in-between the rack and pinion and frame on the passenger side top mounting hole. Install set screw into steering extension make sure set screw goes into groove on rack and pinion shaft. Use the 5/16"+ jam nut on the set screw using a 13mm to tighten. Using a 18mm,19mm socket and 24 mm socket tighten rack and pinion to frame. Plug in the two connectors for rack and pinion. Tighten the bolt that connects the steering shaft to the steering extension using a 11mm socket. **See Photo 32 & 33.**



Photo 32



Photo 33

36. Install diff drop brackets using stock hardware on driver side and new supplied 12mm flange nut for passenger side. Use a 18mm socket or wrench to tighten. **See Photo 34 & 35.** Install diff vent extension tube into stock hose.

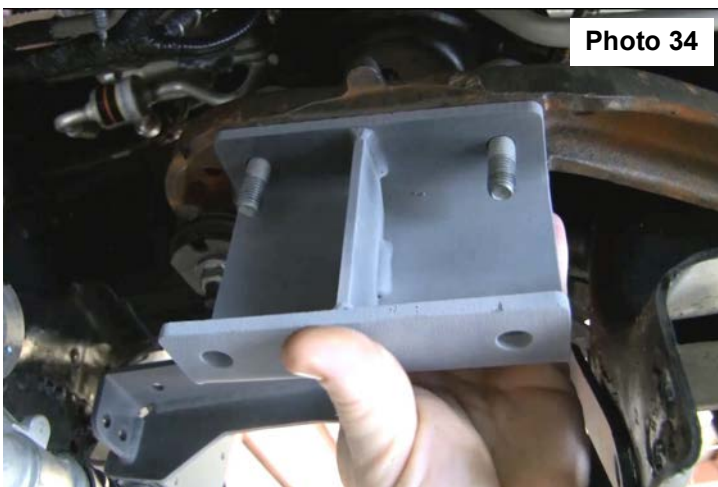
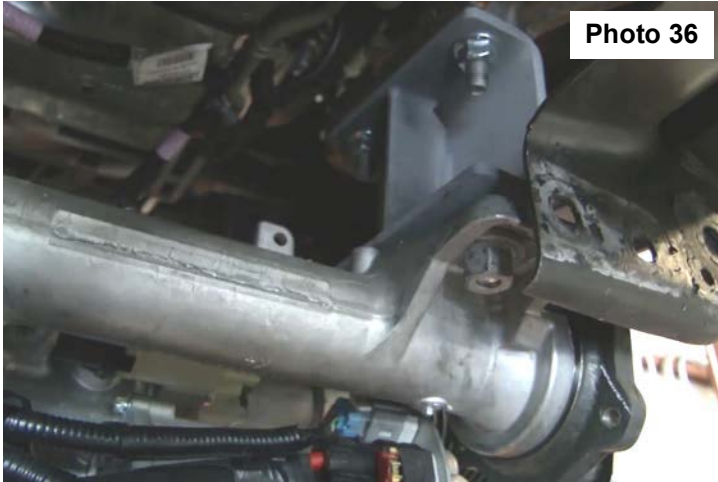

Photo 34

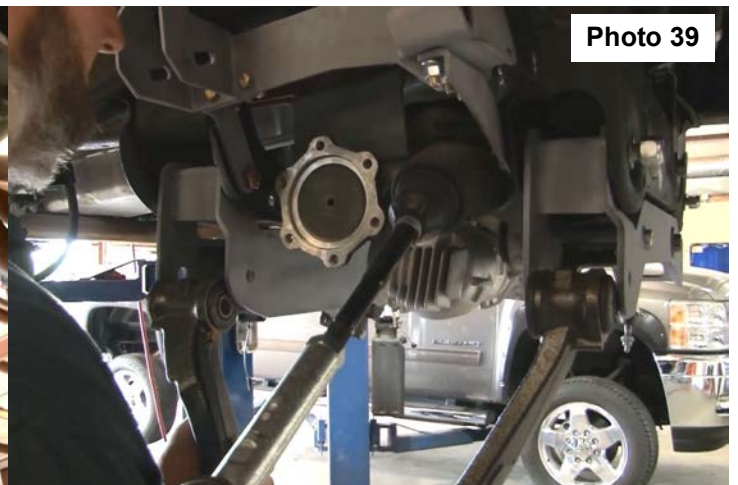
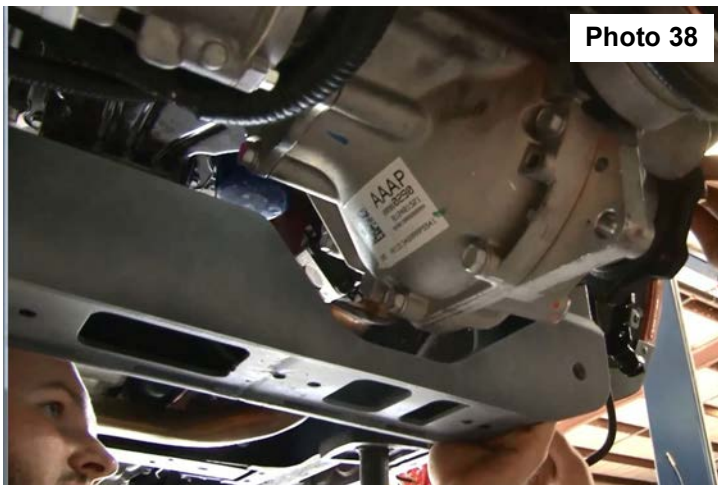

Photo 35

37. Install diff using new supplied 12mm x 45mm bolts and nuts. Be sure not to hit or push diff into rack and pinion. Use new bolts and nut on driver side and use new bolts with old stock nut on passenger side. Use a 18mm and 19mm socket and wrench for new bolts and a 21mm for the stock nuts. Plug in the 4x4 actuator and vent tube. **See Photo 36.**
38. Install driveshaft using stock hardware and a 11mm wrench to tighten. **See Photo 37.**



39. Install rear crossmember using new 5/8"x 5.5" bolts, washer, and nuts. Install bolts front to back of truck. **See Photo 38**
40. Install upper and lower control arms using stock bolts. **See Photo 39.** Then tighten all cross-member and upper control arm drop bolts. Use a 24mm wrench and socket on cross-member bolts. Use a 21mm and a 22mm wrench and socket on upper drops. Then use a 14mm wrench and socket to tighten all 3/8" bolts on upper control arm drop brackets.



41. Install sway-bar drop bracket using 10mm x 35 mm bolts and washers. Tighten using 17mm wrench. **See Photo 40.** Install sway-bar using stock bolt with new 10mm nuts. **See Photo 41.** Use a 10mm socket and 17mm wrench to tighten. Install stock sway-bar link using a 15mm to tighten.

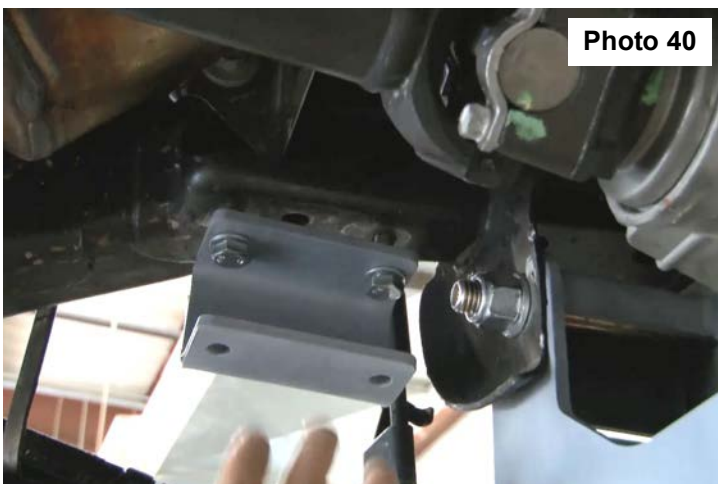

42. Install CV axle using stock hardware and a 15mm socket to tighten.
43. Install brake line bracket using the supplied 3/8"x 1" bolts, washers, and nuts. **See Photo 42.** Use a 13mm wrench and socket to tighten.
44. Press in the 10mm studs into the strut spacer. Install strut spacer on to strut using stock hardware and a 18mm wrench to tighten.
45. Install strut into truck using the supplied 10mm nuts and lock washers. Use a 17mm wrench to tighten. **See Photo 43.** Use the lower strut spacer and supplied 10mm x 90mm bolts, washers, and nuts for lower strut mount. Tighten with a 15mm socket and wrench.



Photo 42



Photo 43

46. Install knuckles using stock hardware. **See Photo 44.** Use a 24mm for lower ball joint a 18mm for upper joint and a 35mm for axle nut. Install rotor and install bolt using a 30mm torx socket. Install the brake caliper using a 18mm socket for the bolts.
47. Install stock brake line bracket to upper control arm using a 10mm socket. Install ABS wire onto the cam lock washers and plug in. Install tie-rod using a 21mm and 10mm to tighten.
48. Adjust the supplied Magneride linkage to 10.375±, center of stud to center of stud, and attach to the factory brackets. Tighten using a 3/8" wrench. **See Photo 45.**



Photo 44



Photo 45

49. Install skid plates using supplied 3/8"x 1.25" bolts and washers. First insert the stock two bolts for upper skid plate and let the lower part hang. Install the bolts to the rear of the lower skid plate first then push the lower skid into place and overlap it with the front skid. The 3/8" bolts will go through both skids into the front crossmember. **See Photo 46.** Use a 14mm and a 15mm socket to tighten all bolts
50. Jack up the truck and remove the jack stands. Lower truck on ground tighten upper and lower control arm bolts using 21mm for upper and 18mm and 24mm socket and wrench for bottom.



Photo 46

REAR INSTALLATION

1. Chock the front tires.
2. Before jacking up the rear of the vehicle. Remove the stock brake line bracket using a 13mm wrench, from the driver side frame rail to allow the extension bracket to be installed. Also remove the clip securing the hard line and wiring harness to the top of the frame. **See Photo 1**. The stock bolts can be accessed from the side of the vehicle. Retain the stock hardware for reuse.
3. Install the brake line bracket to the new bracket with the supplied 5/16+x 3/4+ bolts, nuts /washers. Reinstall the assembly in the stock location with the stock hardware using a 13mm wrench. **See Photo 2**.

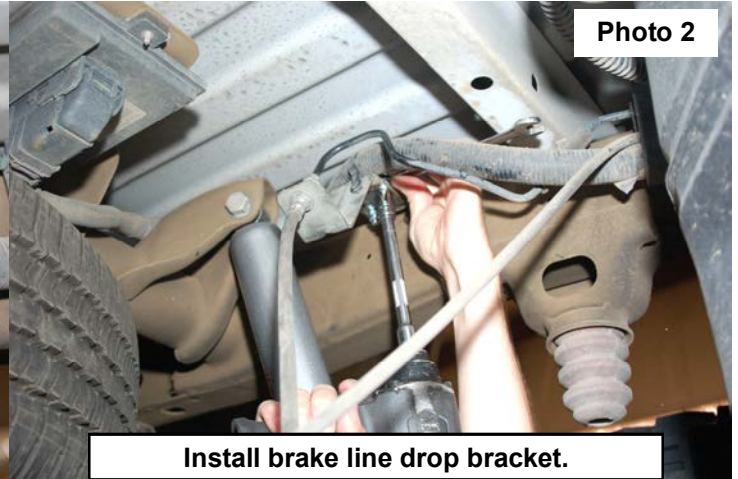

4. Remove the e-brake wire bracket from the frame with a 13mm socket. Use the supplied drop bracket and the factory bolt to mount to the frame. Use the supplied 5/16+x 1-bolt, washers, and nut to mount factory wire bracket to the new drop bracket as shown in **See Photo 3**.
5. Remove the ABS wire, if equipped, from the frame rail as shown in **Photo 4** to allow slack in the line.

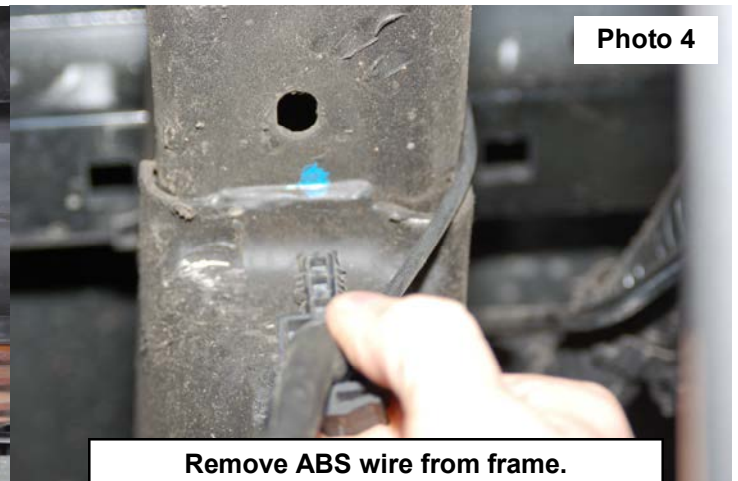
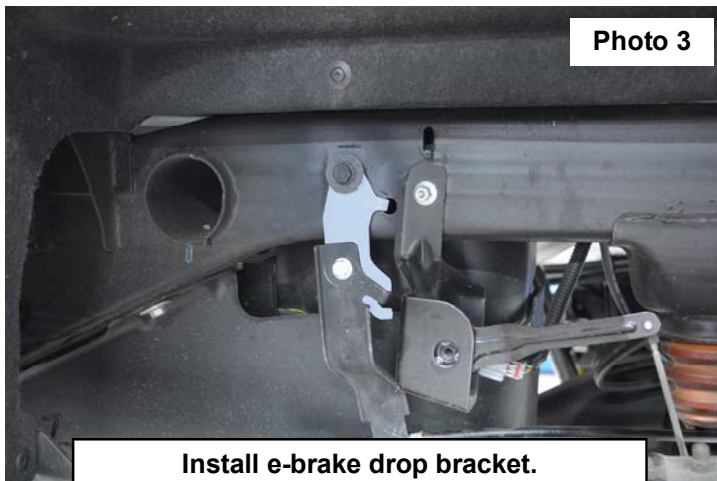

6. Jack up the rear of the vehicle and place jack stands under the frame rails. Remove tire and wheels.
7. Lightly support the differential with a floor jack .
8. Remove the stock shock absorbers using a 21mm wrench. Retain the hardware for reuse.
9. Remove the stock u-bolts and lower the axle to allow the supplied block to be installed. Discard the factory block if so equipped.
10. Remove the MagneRide shim and flatten tab. Reinstall on bottom of leaf pack. **See Photo 5**.

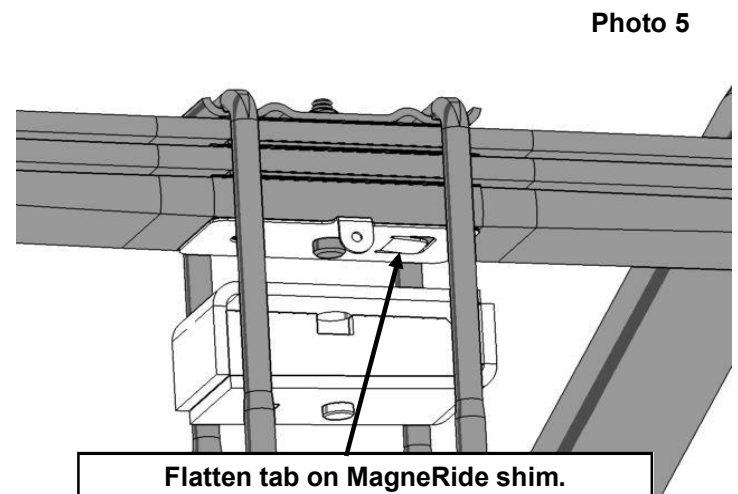

11. Install the new block. Jack up the axle to meet the new block and make sure the center pin is in the axle. **See Photo 6. Note short side of block goes towards front of vehicle.**
12. Install the supplied u-bolts and tighten using a 22mm wrench and a crossing pattern. **See Photo 6.**
13. Use the anti-wrap u-bolts and hardware included in 1263BAG2.
14. Install the Magneride shock relocation brackets in the factory shock mounts using the supplied 14mm x 85mm bolt, nut and washers. **See Photo 7.**
15. Attach the rear of the relocation bracket using the supplied square washer and 1/2"x 1.5"+ bolt and washer. **See Photo 8.**
16. Install Magneride shock in relocation bracket using stock hardware.
17. Using WD-40 lubricate the ABS wire and slide the rubber sleeve up to allow the wire to be reinstalled in the clip on the frame. The connector will not be reattached to the top of the frame. Reroute the lines as needed to gain sufficient slack.
18. Re-install tires and wheels.

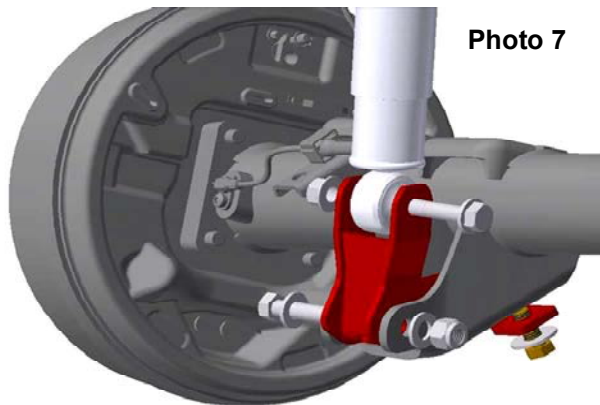
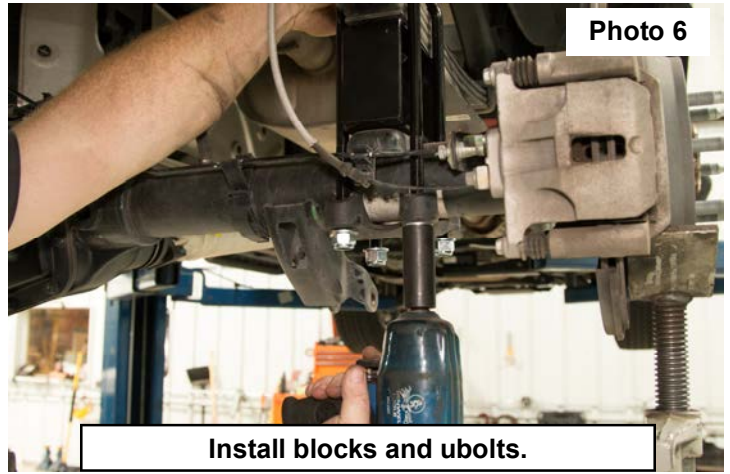

Install Magneride shock relocation brackets.

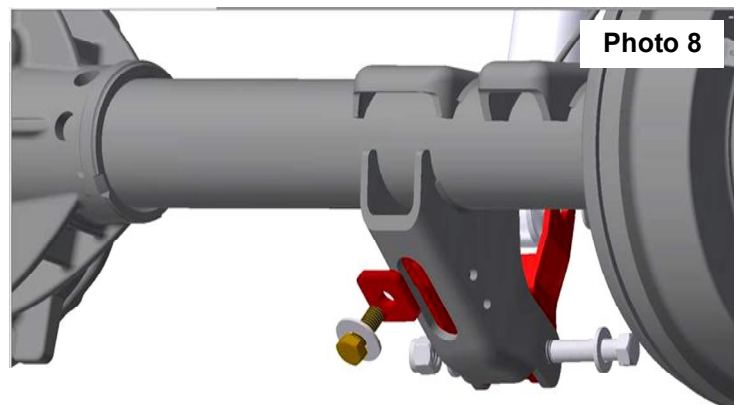

Install Magneride shock relocation brackets.

19. Remove jack stands and lower vehicle to ground.
20. Place window decal on vehicle.

POST INSTALLATION INSTRUCTIONS

1. Check all fasteners for proper torque. Check to ensure for adequate clearance between all rotating, mobile, fixed, and heated members. Verify clearance between exhaust and brake lines, fuel lines, fuel tank, floor boards and wiring harness. Check steering gear for clearance. Test and inspect brake system.
2. Perform steering sweep to ensure front brake hoses have adequate slack and do not contact any rotating, mobile or heated members. Inspect rear brake hoses at full extension for adequate slack. Failure to perform hose check/ replacement may result in component failure.
3. On some vehicles the front lower skirting will need to be trimmed if using certain wheel /tire combinations and with heavy offset wheels. Trim only as needed.
4. Activate four wheel drive system and check front hubs for engagement.
5. Have a qualified alignment center align the vehicle immediately. Realign to factory specifications. The following are the recommended specifications:

Caster in degrees	4.5 +/-1.0
Camber in degrees	0.0- .3
Toe In in degrees	0.1 +/- .2
6. Perform head light check and adjustment to proper settings.
7. Check and retighten wheels at 50 miles and again at 500 miles.
8. All kit components must be retightened at 500 miles and then every three thousand miles after installation. Periodically check all hardware for tightness.
9. Install ~~W~~arning to Driver+decal on sun visor

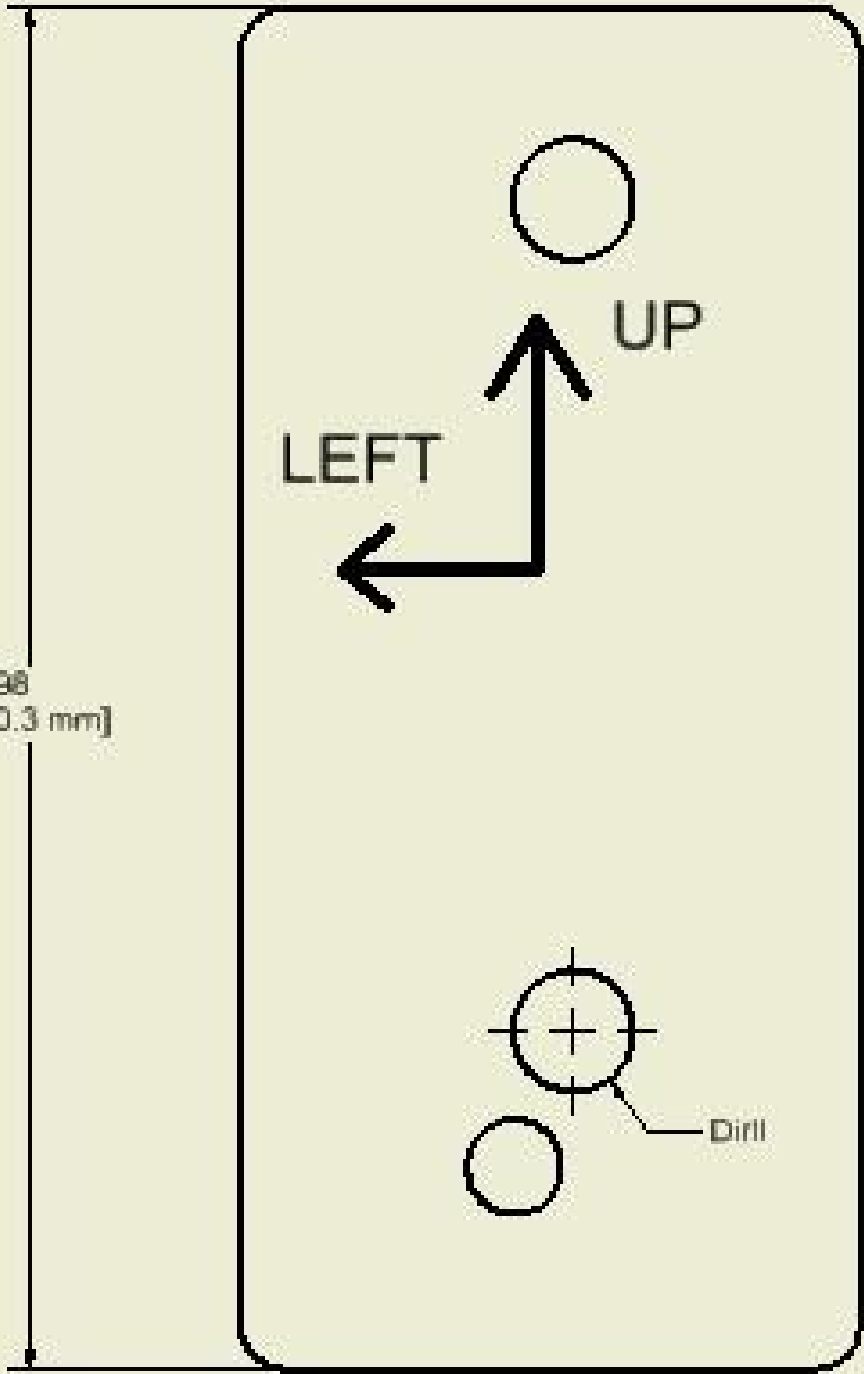

UP
LEFT

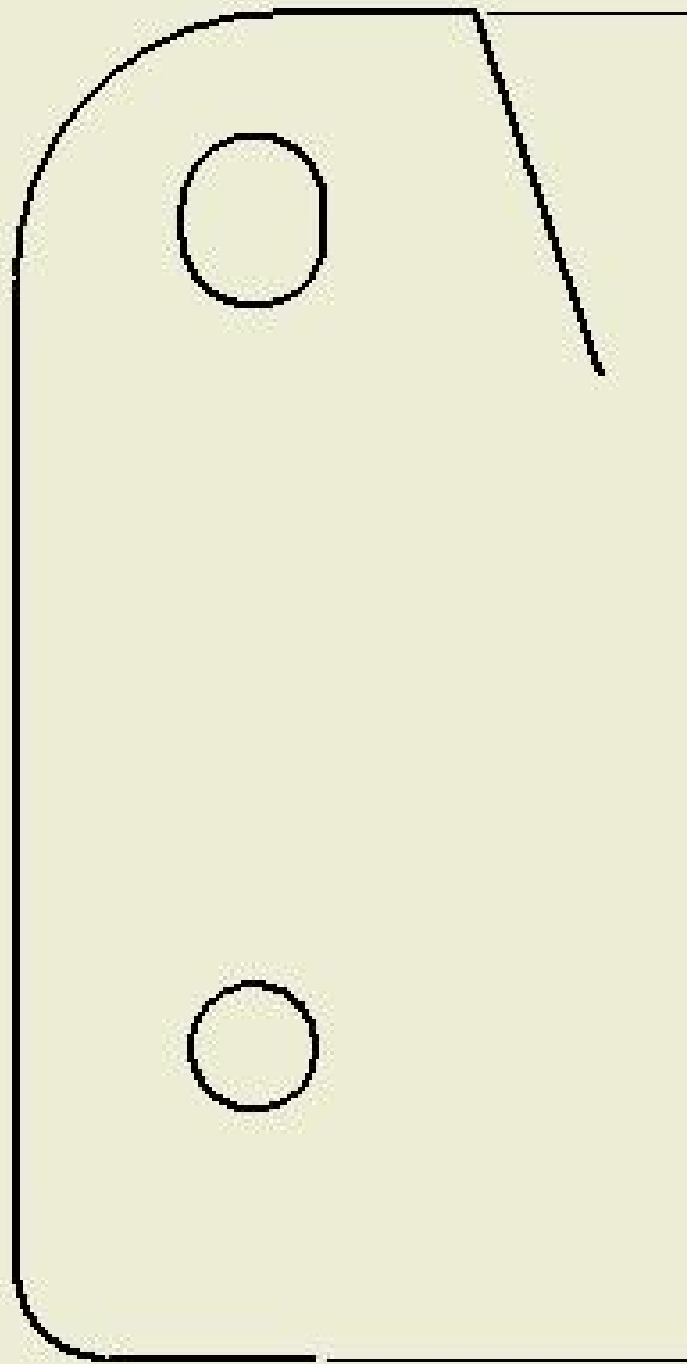
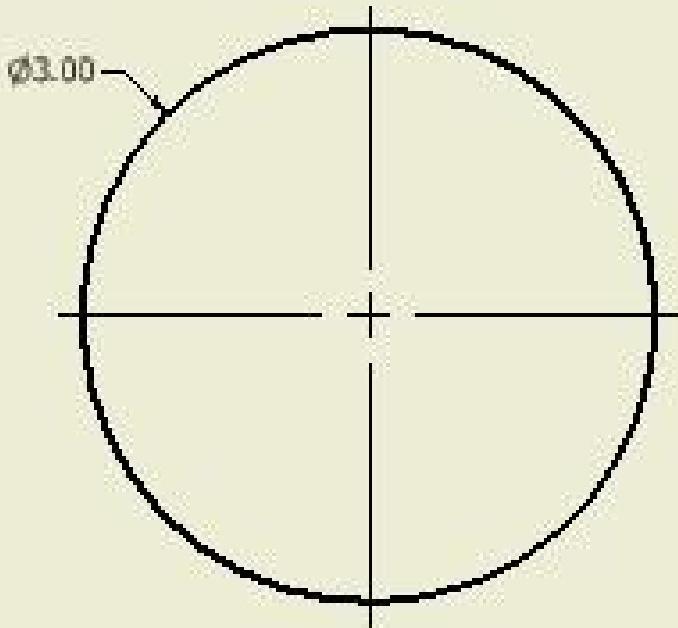

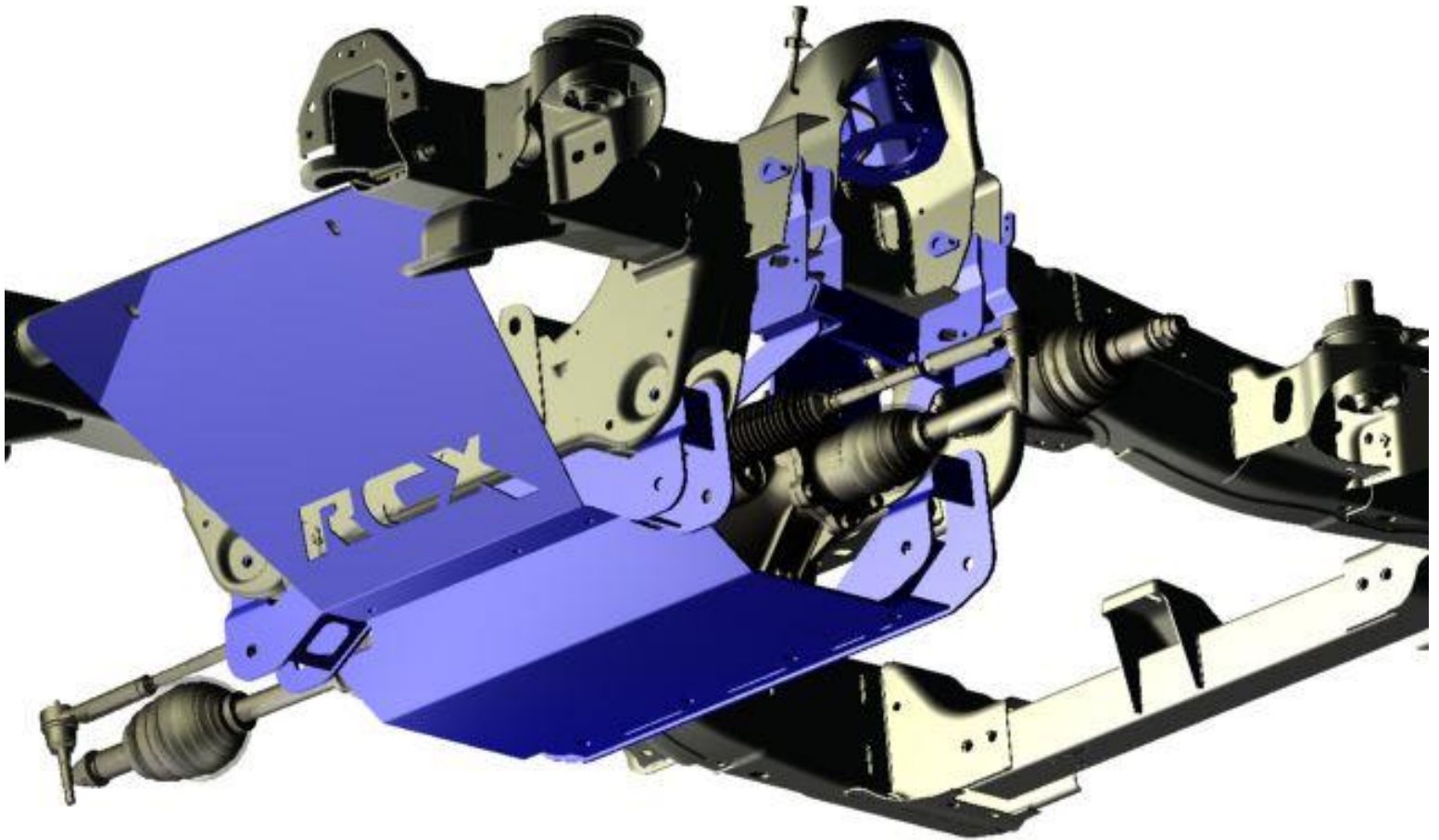

Thank you for choosing Rough Country for all of your suspension needs.

By purchasing any item sold by Rough Country, LLC, the buyer expressly warrants that he/she is in compliance with all applicable , State, and Local laws and regulations regarding the purchase, ownership, and use of the item. It shall be the buyers responsibility to comply with all Federal, State and Local laws governing the sales of any items listed, illustrated or sold. The buyer expressly agrees to indemnify and hold harmless Rough Country, LLC for all claims resulting directly or indirectly from the purchase, ownership, or use of the items.

