

IMPORTANT NOTICE:

Vehicle Owner MUST Read This Information Prior To Operating Vehicle

Notice to Owner, Operator, Dealer and Installer :

It is the Dealer/Installer's mandatory responsibility to provide this Warranty Disclosure & Information Policy to the vehicle Owner/Customer in which the ReadyLIFT® Off Road Suspension kit is being installed. ReadyLIFT® Off Road Suspension's Mid-Travel and Long Travel suspension systems and components are designed for OFF ROAD USE ONLY. Vehicles that have been enhanced for off road performance often have unique handling characteristics due to a higher center of gravity and larger tires. Because of the increased track width and suspension articulation along with the disconnection of the front sway bar these vehicles may handle, react and stop differently than many passenger cars or unmodified vehicles, both on and off road.! Therefore use of these off road products on the street is at the consumer's own discretion so you must drive your vehicle safely. Extreme care should always be taken to prevent vehicle rollover or loss of control, which can result in serious injury or even death. Always avoid sharp turns or abrupt maneuvers and allow more time and distance for braking! ReadyLIFT® reminds you to fasten your seat belts at all times and reduce speed! We will gladly answer any questions concerning the design, function, maintenance and correct use of our products.

Proper installation and proper use of all mid travel and long travel products must be followed for optimal safety and performance. Please make sure that the Dealer/Installer explains and delivers all warning notices, warranty forms, and instruction sheets included with ReadyLIFT® Off Road product.

Please note that certain mechanical aspects of any suspension lift product may accelerate ordinary wear of original equipment components. Further, installation of certain ReadyLIFT® products may void the vehicles factory warranty as it pertains to certain covered parts; it is the consumer's responsibility to check with their local dealer for warranty coverage before installation of the lift.

Be advised that the purchase and installation of ReadyLIFT® Off Road Suspension systems and components is an acknowledgement of acceptance of fore mentioned policy. ReadyLIFT® does not accept any responsibility for improper use, alterations, and installation of any mid and long travel products purchased. ReadyLIFT® Suspension and its distributors will not be responsible for any damages or injuries resulting from improper usage or installation.



ROLLOVER HAZARD:

Modified Suspensions and large-diameter tires that increase ground clearance will alter vehicle handling.

- **The vehicle may become more likely to roll over.**
- **Braking distance may increase.**
- **Slower speeds may be required to maintain control of the vehicle.**

Drive with extreme caution until you become familiar with how your vehicle handles. Always wear your seat belt. Always check lug nut tightness. Always check to make sure tires are inflated to tire manufacturer specifications. Some modifications may be illegal in your state. Consult your owner's manual, the instructions for this product, and state law before modifying your vehicle. ReadyLIFT Suspension Inc. is not responsible for damage or loss due to abusive driving.

WARRANTY INFORMATION

Please Read

Installation of this ReadyLIFT® Off Road Suspension Product signifies the Owner agree with the terms of this Warranty. ReadyLIFT® Off Road Suspension warranty applies to the original retail purchaser who owns the vehicle on which the ReadyLIFT® Off Road Suspension product was originally installed. ReadyLIFT Off Road Suspension warranty does not apply to the product which as been altered, modified and/or defects resulting from installation contrary to the instructions for ReadyLIFT® Off Road Suspension products. Warranty does not cover damaged finish resulting from installation or driving abuse. ReadyLIFT® Off Road Suspension products are not designed, nor are they intended to be installed on vehicles used in race applications, for racing purposes or for similar activities. ReadyLIFT® Off Road Suspension defines a RACE as any contest between two or more vehicles, or a contest of one or more vehicles against the clock, whether or not such contest is for a prize). This warranty does not include coverage for police or taxi vehicles, race vehicles, or vehicles used for government or commercial purposes. Also excluded from this warranty are sales outside of the United States of America and Canada.

ReadyLIFT® Off Road Suspension's obligation under this warranty is limited to the repair or replacement, at ReadyLIFT® Off Road Suspensions' discretion, of the defective product. Any and all costs of removal, installation or re-installation, freight charges and incidental or consequential damages are expressly excluded from this warranty. Items that are subject to wear are not considered defective when worn and are not covered by the warranty.

ReadyLIFT® Off Road Suspension components must be installed as a complete kit as shown in our current application guide and installation instructions. Any substitutions or exemptions of required components will immediately void the warranty. This warranty is expressly in lieu of all other warranties expressed or implied. This warranty shall not apply to any product that has been improperly installed, modified or customized subject to accident, negligence, abuse or misuse.

Limited Warranty details for ReadyLIFT® Off Road Suspension control arms and steering kits NOT sold as components of any ReadyLIFT® Off Road Suspension Lift or Off Road Kit:

The ReadyLIFT® Off Road Suspension Limited Lifetime Warranty covers defective materials or defective workmanship for the life of the product to the original purchaser and only on the original vehicle which the product was installed. The ReadyLIFT® Off Road Suspension Limited Lifetime Warranty excludes the following wearable items:

bushings, bushing sleeves, bump stops, top-out stops, spherical bearings (uniballs), heim joints (rod ends), and misalignment spacers (upper control arm and steering). These items are considered wear items and are covered for 90 days from the original purchase date, therefore these items will not be considered defective because of wear. Wear is subject to use of product, use of vehicle, driving conditions, weather conditions, cleanliness of product/components, and maintenance/up-keep. The degree of wear and overall lifetime of each wear item is subject to afore mentioned conditions and circumstances. ReadyLIFT® Off Road Suspension will only warranty wear items in the case of workmanship and defects for the period of 90 days following the date of purchase.

Please note that all products should be inspected by a professional technician before installing any part/kit onto the vehicle. In addition, all products should be installed by a qualified technician. Please contact ReadyLIFT® Off Road Suspension if there is any question as to the quality of workmanship of each component or its installation procedure. Contact ReadyLIFT® Off Road Suspension directly about any potentially defective parts prior to removing any parts from the vehicle. If it appears that the part is warrantable, you will be given an RGA number and asked to return the part freight prepaid. If the part is found to be warrantable, at the sole discretion of ReadyLIFT® Off Road Suspension, it will be repaired or replaced and returned to you. The limited warranty expressed by ReadyLIFT® Off Road Suspension supersedes that of any claims made by authorized and unauthorized dealers of ReadyLIFT® Off Road Suspension products.

cut here

cut here

You Must Register Your ReadyLIFT® Product to Activate Your Warranty.
Please visit www.readylift.com, select your ReadyLIFT® Off Road product,
and register your product.

If you do not have access to the internet or www.readylift.com, please fill out this warranty form and mail to ReadyLIFT to complete your warranty registration.

Mail To: ReadyLIFT Off Road Warranty, 7490 Commercial Way, Henderson, NV 89011 or FAX to 702-410-2794

Name: _____ Address: _____

City: _____ State: _____ Zip: _____ Phone: _____

Email: _____ Vehicle Make/Model: _____ Year _____

Product Name _____ Product SKU: _____

Purchase Date: _____ Purchased From: _____

Warranty Number: _____



Consumer Warning and Responsibility for MLS Lift Kits

Notice to Installer: This packet must be given directly to the end user of this kit. It contains warnings and responsibilities that must be reviewed with the end user.

(800)549-4620

EMAIL: INFO@ReadyLIFT.COM

WEBSITE: www. ReadyLIFT.COM

****Please retain this document in your vehicle at all times****

ReadyLIFT® Off Road Suspension Limited Warranty

Limited Warranty details for ReadyLIFT® Off Road Suspension control arms and steering kits

The ReadyLIFT® Off Road Suspension Limited Lifetime Warranty covers defective materials or defective workmanship for the life of the product to the original purchaser and only on the original vehicle which the product was installed. The ReadyLIFT® Off Road Suspension Limited Lifetime Warranty excludes the following wearable items: bushings, bushing sleeves, bump stops, top-out stops, spherical bearings (uniballs), heim joints (rod ends), and misalignment spacers (upper control arm and steering). These items are considered wear items and are covered for 90 days from the original purchase date, therefore these items will not be considered defective because of wear. Wear is subject to use of product, use of vehicle, driving conditions, weather conditions, cleanliness of product/components, and maintenance/up-keep. The degree of wear and overall lifetime of each wear item is subject to afore mentioned conditions and circumstances. ReadyLIFT® Off Road Suspension will only warranty wear items in the case of workmanship and defects for the period of 90 days following the date of purchase. Please note that all products should be inspected by a professional technician before installing any part/kit onto the vehicle. In addition, all products should be installed by a qualified technician. Please contact ReadyLIFT® Off Road Suspension if there is any question as to the quality of workmanship of each component or its installation procedure. Contact ReadyLIFT® Off Road Suspension directly about any potentially defective parts prior to removing any parts from the vehicle. If it appears that the part is warrantable, you will be given an RGA number and asked to return the part freight prepaid. If the part is found to be warrantable, at the sole discretion of ReadyLIFT® Off Road Suspension, it will be repaired or replaced and returned to you. **The limited warranty expressed by ReadyLIFT® Off Road Suspension supersedes that of any claims made by authorized and unauthorized dealers of ReadyLIFT® Off Road Suspension products.**

www.ReadyLIFT.com



Consumer Warning and Responsibility for MLS Lift Kits

Please read Instructions thoroughly and completely before beginning installation.

Installation by a certified mechanic is recommended.

ReadyLIFT® Off Road Suspension is **NOT** responsible for any damage or failure resulting from improper installation.

Safety Warning: Suspension systems or components that enhance the on and off-road performance of your vehicle may cause it to handle differently than it did from the factory. Extreme care must be used to prevent loss of control or vehicle roll-over during abrupt maneuvers. Always operate your vehicle at reduced speeds to ensure your ability to control your vehicle under all driving conditions. Failure to drive safely may result in serious injury or death to driver and passengers. Driver and passengers must ALWAYS wear your seat belts, avoid quick sharp turns and other sudden maneuvers. ReadyLIFT® Off Road Suspension does not recommend the combined use of suspension lifts, body lifts, or other lifting devices. You should never operate your vehicle under the influence of alcohol or drugs. Constant maintenance is required to keep your vehicle safe. Thoroughly inspect your vehicle before and after every off-road use. It is the responsibility of the retailer and/or the installer to review all state and local laws, with the end user of this product, related to bumper height laws and the lifting of their vehicle before the purchase and installation of any ReadyLIFT® products. It is the responsibility of the driver/s to check their surrounding area for obstructions, people, and animals before moving the vehicle. All raised vehicles have increased blind spots and damage, injury and/or death can occur if these instructions are not followed.

Installation Warning: All steps and procedures described in these instructions were performed while the vehicle was properly supported on a two post vehicle lift with safety jacks. Use caution during all disassembly and assembly steps to insure suspension components are not over extended causing damage to any vehicle components and parts included in this kit. Included instructions are guidelines only for recommended procedures and are not meant to be definitive. Installer is responsible to insure a safe and controllable vehicle after performing modifications.

ReadyLIFT® Off Road Suspension recommends the use of an OE Service Manual for model/year of vehicle when disassembly and assembly of factory and related components. Unless otherwise specified, tighten all bolts and fasteners to standard torque specifications listed within the OE Service Manual, or as referenced in the torque specification list provided in these instructions.

Suspension components that use rubber or urethane bushings should be tightened with the vehicle at normal ride height. This will prevent premature wear or failure of the bushing and maintain ride comfort. Larger tire and wheel combinations may increase leverage on suspension, steering, and related components. Due to payload options and initial ride height variances, the amount of lift is a base figure. Final ride height dimensions may vary in accordance to original vehicle ride height. Always measure the vehicle ride height prior to beginning installation.

Vehicle ride height chart

Driver Front:	Driver Rear:	Pass. Front:	Pass. Rear:
<input type="text"/>	<input type="text"/>	<input type="text"/>	<input type="text"/>

Bolt Size Millimeters	Torque Specs in FT/LB	
	Metric Grade 8.8	Metric Grade 10.9
6mm	6	8
8mm	16	22
10mm	40	45
12mm	54	70
14mm	89	117
16mm	132	175
18mm	182	236

Bolt Size SAE	Torque Specs in FT/LB	
	Grade 5	Grade 8
5/16	15	20
3/8	30	35
7/16	45	60
1/2	65	90
9/16	95	130
5/8	135	175
3/4	185	280



Consumer Warning and Responsibility for MLS Lift Kits

Safety Warning

Before you start installation:

ReadyLIFT® Off Road Suspension highly recommends that the installation of this product be performed by a professional mechanic with experience working on and installing suspension products. Professional knowledge and skill will typically yield the best installation results. If you need an installer in your area, please contact ReadyLIFT® Suspension customer service to find one of our "Pro-Grade" Dealers.

Notes:

- Installation by a professional mechanic is highly recommended.
- A Factory Ford Service Manual for your specific Year / Make / Model is highly recommended for reference during installation.
- Installation requires cutting and welding of the vehicle frame.
- Vehicles with a two piece rear driveline may require a carrier bearing drop support bracket, call technical assistance for details.
- Vehicles achieving more than 5" of rear lift may require rear driveline modifications, call technical assistance for details.
- All lifted vehicles may require additional driveline modifications and or balancing.
- A four wheel vehicle alignment will need to be performed after installation of this product.
- Speedometer / Computer recalibration is required if changing +/- 10% from factory tire diameter.
- Use of a Vehicle Hoist will greatly reduce installation time. Vehicle must be in excellent operating condition.
- Repair or replace any and all worn or damaged components prior to installation.

Final Checks & Adjustments

Post Installation Warnings: Once the vehicle is lowered to the ground, check all parts which have rubber or urethane components to insure proper torque. Torque wheels to factory specs. Move vehicle backwards and forwards a short distance to allow suspension components to adjust. Turn the front wheels completely left then right and verify adequate tire, wheel, brake line, and ABS wire clearance. Test and inspect steering, brake and suspension components for tightness and proper operation. Inspect brakes hoses and ABS lines for adequate slack at full extension. Failure to perform the post inspection checks may result in vehicle component damage and/or personal injury or death to driver and/or passengers. Test drive vehicle and re-check the torque of all fasteners and re-torque wheels on vehicle. Re-adjust headlamps.

Vehicle Handling Warning: Vehicles with larger tires and wheels will handle differently than stock vehicles. Take time to familiarize yourself with the handling of your vehicle.

Wheel Alignment/Headlamp Adjustment:

It is necessary to have a proper and professional wheel alignment performed by a certified alignment technician. Align the vehicle to factory specifications. It is recommended that your vehicle alignment be checked after any off-road driving. In addition to your vehicle alignment, for your safety and others, it is necessary to check and adjust your vehicle headlamps for proper aim and alignment

Vehicle Re-Torque and Safety Inspection:

Upon completion of all services and adjustments performed on your vehicle, and within 50 miles of driving, check to ensure all fasteners and hardware are properly torqued to specification as noted in the vehicles factory service manual or the torque chart included.



Consumer Warning and Responsibility for MLS Lift Kits

- IMPORTANT WARNINGS -

This card and all other end user warnings and responsibilities **must be** read and understood before operating this modified truck.

Note to Installer: This card must be hung from the rear view mirror in plain view of the end user of this kit.

- Rollover & Blind Spot Warning -

Please read and understand this warning card.

Warning: Modified Suspensions and larger diameter tires that increase ground clearance will alter vehicle handling and increase blind spots.

WARNING:

- The truck may become more likely roll over.
- Braking distance may increase.
- Slower speeds may be needed to maintain control in some driving conditions.
- Greater caution will be necessary due to increased blind spots all the way around the truck.
- Drive with extreme caution until you become familiar with how your modified vehicle handles.
- Always wear your seat belt.
- Always check lug nuts and tire pressure are at manufactures specifications.
- You must adjust headlights.
- Some modifications may be illegal in your state.
- Consult your owners manual, installation instructions, and state laws before modifying your vehicle.



ReadyLIFT Off Road Suspension is not responsible for damage or loss due

Note to Installer: This card must be hung from the rear view mirror in plain view of the end user of this kit.

- IMPORTANT WARNINGS -

This GMC Lift Kit is certified compliant and has passed the FMVSS-126 testing.

● This card and all other end user warnings and responsibilities **must be** read and understood before operating this modified truck.

Note to Installer: This card must be hung from the rear view mirror in plain view of the end user of this kit.

Turn Over

- IMPORTANT WARNINGS -

This GMC Lift Kit is certified compliant and has passed the FMVSS-126 testing.

● This card and all other end user warnings and responsibilities **must be** read and understood before operating this modified truck.

Note to Installer: This card must be hung from the rear view mirror in plain view of the end user of this kit.

Turn Over

- Rollover & Blind Spot Warning -

Please read and understand this warning card.

Warning: Modified Suspensions and larger diameter tires that increase ground clearance will alter vehicle handling and increase blind spots.

WARNING:

- The truck may become more likely roll over.
- Braking distance may increase.
- Slower speeds may be needed to maintain control in some driving conditions.
- Greater caution will be necessary due to increased blind spots all the way around the truck.
- Drive with extreme caution until you become familiar with how your modified vehicle handles.
- Always wear your seat belt.
- Always check lug nuts and tire pressure are at manufactures specifications.
- You must adjust headlights.
- Some modifications may be illegal in your state.
- Consult your owners manual, installation instructions, and state laws before modifying your vehicle.

ReadyLIFT Off Road Suspension is not responsible for damage or loss due to abusive or impaired driving.



Note to Installer: This card must be hung from the rear view mirror in plain view of the end user of this kit.

Turn Over

- Rollover & Blind Spot Warning -

Please read and understand this warning card.

Warning: Modified Suspensions and larger diameter tires that increase ground clearance will alter vehicle handling and increase blind spots.

WARNING:

- The truck may become more likely roll over.
- Braking distance may increase.
- Slower speeds may be needed to maintain control in some driving conditions.
- Greater caution will be necessary due to increased blind spots all the way around the truck.
- Drive with extreme caution until you become familiar with how your modified vehicle handles.
- Always wear your seat belt.
- Always check lug nuts and tire pressure are at manufactures specifications.
- You must adjust headlights.
- Some modifications may be illegal in your state.
- Consult your owners manual, installation instructions, and state laws before modifying your vehicle.

ReadyLIFT Off Road Suspension is not responsible for damage or loss due to abusive or impaired driving.



Note to Installer: This card must be hung from the rear view mirror in plain view of the end user of this kit.

Turn Over



Installation Instructions 7" Lift Kit 2015 F150 4WD ONLY(44-2575)

IF YOUR ReadyLIFT® OFF ROAD SUSPENSION PRODUCT IS MISSING A PART OR HAS A DAMAGED PART, PLEASE CONTACT CUSTOMER SERVICE DIRECTLY.

A NEW REPLACEMENT PART WILL BE SENT TO YOU IMMEDIATELY

(800) 549-4620

MON-FRI 7AM-5PM PST

OR

EMAIL: INFO@ReadyLIFT.COM

WEBSITE: www.ReadyLIFT.COM

****Please retain this document in your vehicle at all times****

ReadyLIFT® Off Road Suspension Limited Warranty

Limited Warranty details for ReadyLIFT® Off Road Suspension.

The ReadyLIFT® Off Road Suspension Limited Lifetime Warranty covers defective materials or defective workmanship for the life of the product to the original purchaser and only on the original vehicle which the product was installed. The ReadyLIFT® Off Road Suspension Limited Lifetime Warranty excludes the following wearable items: bushings, bushing sleeves, bump stops, top-out stops, spherical bearings (uniballs), heim joints (rod ends), and misalignment spacers (upper control arm and steering). These items are considered wear items and are covered for 90 days from the original purchase date, therefore these items will not be considered defective because of wear. Wear is subject to use of product, use of vehicle, driving conditions, weather conditions, cleanliness of product/components, and maintenance/up-keep. The degree of wear and overall lifetime of each wear item is subject to afore mentioned conditions and circumstances. ReadyLIFT® Off Road Suspension will only warranty wear items in the case of workmanship and defects for the period of 90 days following the date of purchase. Please note that all products should be inspected by a professional technician before installing any part/kit onto the vehicle. In addition, all products should be installed by a qualified technician. Please contact ReadyLIFT® Off Road Suspension if there is any question as to the quality of workmanship of each component or its installation procedure. Contact ReadyLIFT® Off Road Suspension directly about any potentially defective parts prior to removing any parts from the vehicle. If it appears that the part is warrantable, you will be given an RGA number and asked to return the part freight prepaid. If the part is found to be warrantable, at the sole discretion of ReadyLIFT® Off Road Suspension, it will be repaired or replaced and returned to you. **The limited warranty expressed by ReadyLIFT® Off Road Suspension supersedes that of any claims made by authorized and unauthorized dealers of ReadyLIFT® Off Road Suspension products.**

www.ReadyLIFT.com



Installation Instructions 7" Lift Kit 2015 F150 4WD ONLY(44-2575)

Please read Instructions thoroughly and completely before beginning installation.
Installation by a certified mechanic is recommended.

ReadyLIFT® Off Road Suspension is NOT responsible for any damage or failure resulting from improper installation.

Safety Warning: Suspension systems or components that enhance the on and off-road performance of your vehicle may cause it to handle differently than it did from the factory. Extreme care must be used to prevent loss of control or vehicle rollover during abrupt maneuvers. Always operate your vehicle at reduced speeds to ensure your ability to control your vehicle under all driving conditions. Failure to drive safely may result in serious injury or death to driver and passengers. Driver and passengers must ALWAYS wear your seat belts, avoid quick sharp turns and other sudden maneuvers. ReadyLIFT® Off Road Suspension does not recommend the combined use of suspension lifts, body lifts, or other lifting devices. You should never operate your vehicle under the influence of alcohol or drugs. Constant maintenance is required to keep your vehicle safe. Thoroughly inspect your vehicle before and after every off-road use. It is the responsibility of the retailer and/or the installer to review all state and local laws, with the end user of this product, related to bumper height laws and the lifting of their vehicle before the purchase and installation of any ReadyLIFT® products. It is the responsibility of the driver/s to check their surrounding area for obstructions, people, and animals before moving the vehicle. All raised vehicles have increased blind spots and damage, injury and/or death can occur if these instructions are not followed.

Installation Warning: All steps and procedures described in these instructions were performed while the vehicle was properly supported on a two post vehicle lift with safety jacks. Use caution during all disassembly and assembly steps to insure suspension components are not over extended causing damage to any vehicle components and parts included in this kit. Included instructions are guidelines only for recommended procedures and are not meant to be definitive. Installer is responsible to insure a safe and controllable vehicle after performing modifications.

This suspension system was developed using a 35" x 12.5" tire with 20" x 9" wheel and a offset of +25mm. If wider tires are used, offset wheels may be necessary and trimming may be required. Factory wheels can be used but are not recommended with tires over 11" wide. The stock spare rim can be run in an emergency. Please note that if running the spare factory tire, it is done for short distances and a speed not to exceed 45mph or damage to differentials may occur.

VEHICLE MEASUREMENTS

Driver Front:	Driver Rear:	Pass. Front:	Pass. Rear:
<input type="text"/>	<input type="text"/>	<input type="text"/>	<input type="text"/>



Installation Instructions 7" Lift Kit 2015 F150 4WD ONLY(44-2575)

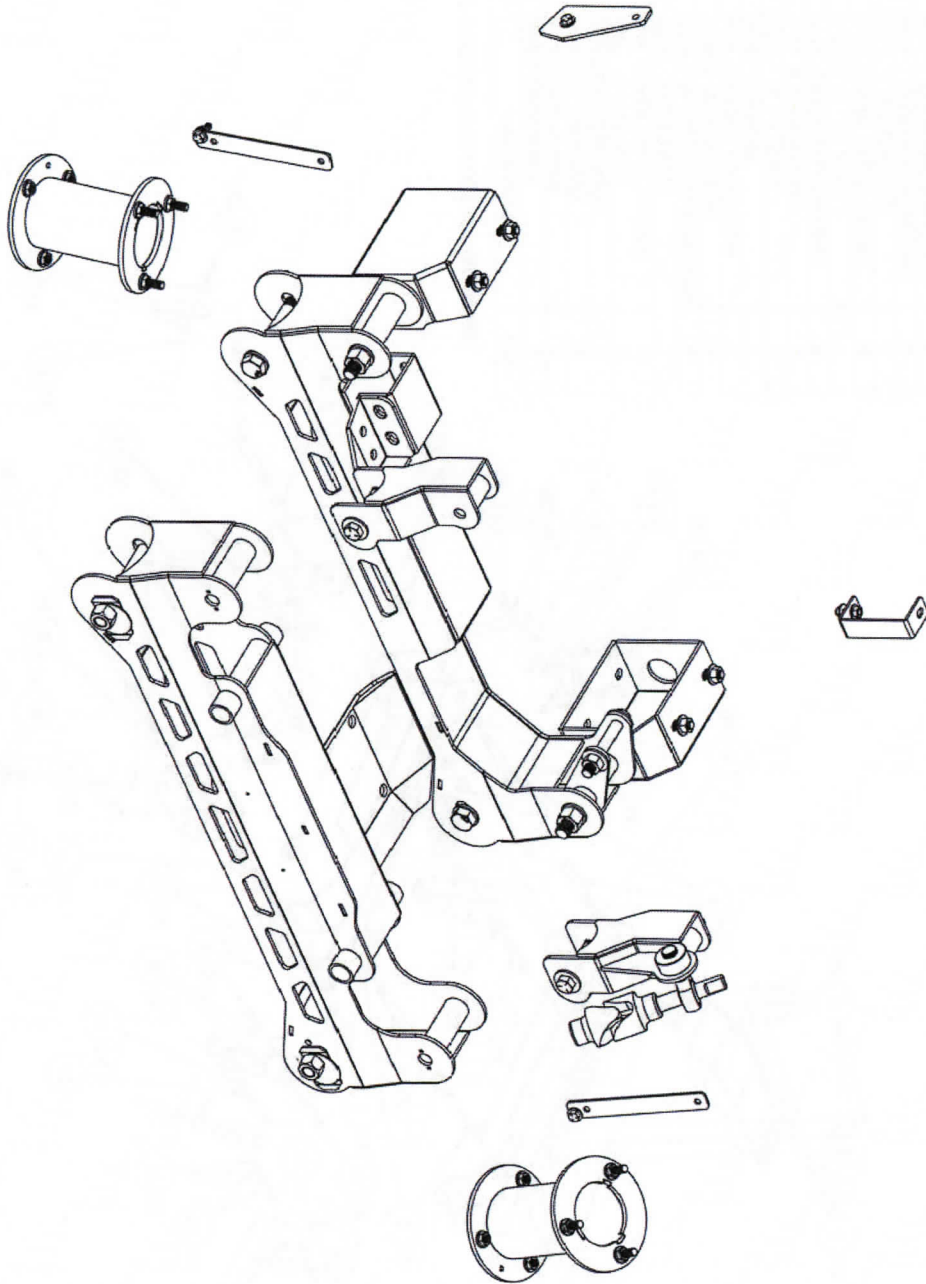



Installation Instructions 7" Lift Kit 2015 F150 4WD ONLY(44-2575)

ITEM NO.	PART NUMBER	QTY.
1	M18-2.5 STOVER NUT	2
2	M18-2.5 FLAT WASHER	8
3	M18-2.5 X 1.50MM BOLT	2
4	M18-2.5 X 1.40MM BOLT	4
5	3/8" - 16 X 1.0 BOLT	6
6	3/8" GRADE 8 FLAT WASHER	6
7	9/16" - 18 X 4.0 BOLT	3
8	9/16" - 18 GRADE 8 FLAT WASHER	6
9	9/16" X 18 STOVER NUT	3
10	M14 - 2 X 90MM ALLEN SCREW	1
11	M14 FLAT WASHER	1
12	7/16" - 14 X 1.25 BOLT	4
13	7/16" X 14 STOVER NUT	4
14	7/16" GRADE 8 FLAT WASHER	8
15	5/16" X 18 - 1.0 BOLT	4
16	5/16" GRADE 8 FLAT WASHER	8
17	5/16" X 18 STOVER NUT	4
18	M10 - 1.25 SERRATED FLANGE NUT	6
19	M10 - 1.50 SERRATED FLANGE NUT	6
20	CAM ADJ PLATE & NUT	4

NOTE: DOES NOT INCLUDE OEM HARDWARE

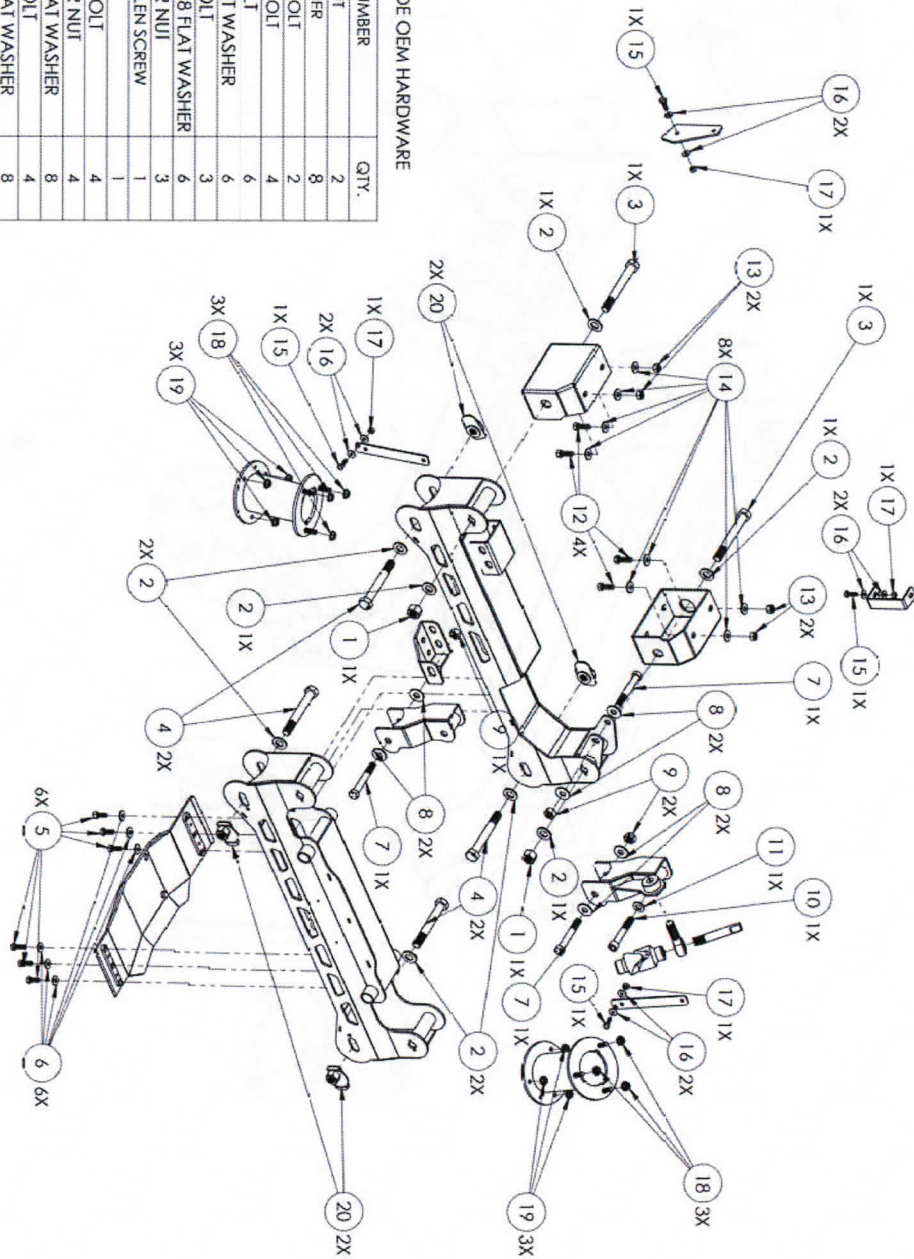



Installation Instructions 7" Lift Kit 2015 F150 4WD ONLY(44-2575)

Bill of Materials

<i>44-2575-1 (Box 1 of 7)</i>		
48-2115	Assembly, Front Cross Member	1
48-2215	Assembly, Rear Cross Member	1
48-2905	Hardware Pack, F&R Cross Member	1
	Bolt, 18mm x 2.5 x 150mm, 10.9 Hex Head	2
	Bolt, 18mm x 2.5 x 140mm, 10.9 Hex Head	4
	Cam Adj Plate and Nut	4
	Nut, m18-2.5 Stover	2
	Washer, M18 washer, flat	8
48-2351	Front Differential Skid Plate	1
48-2937	Front Skid Plate Hardware Pack	1
	Bolt, Grade 8, 3/8" - 16 x 1.00", Hex Head	6
	Washer, 3/8" Grade 8, Flat	6
48-2910	Instructions and Warranty	1
<i>44-2575-2 (Box 2 of 7)</i>		
48-2403	Steering Knuckle - Pass Side	1
<i>44-2575-3 (Box 3 of 7)</i>		
48-2402	Steering Knuckle - Driver Side	1
<i>44-2575-4 (Box 4 of 7)</i>		
48-2301	Differential Drop, Pass Side	1
48-2300	Differential Drop, Driver Side	1
48-2305	Differential Support Bracket	1
48-2931	Hardware Pack, Diff Breather	1
	5/16" Barbed Straight Connector	1
	5/16" Neoprene Rubber Tubing	1
48-2315	Steering Extension Assembly	1
48-2303-5	Steering Extension Shaft	1
48-2303-2	Universal Joint	1
48-2303-4	Rod End, 3/4" x 3/4"	1
	Set Screws—Pre-installed	
48-2360	Front Driveshaft Spacer	1
48-2936	Hardware Pack, Ft Driveshaft	1
	Bolt, 10mm x 1.5 x 100mm, Allen	6

<i>44-2575-4 (Box 4 of 7) Continued</i>		
48-2941	Hardware PK, Diff - Steer	1
	Bolt, 14mm-2.0 x 90mm Allen Screw	1
	Washer, 14mm Flat	1
	Bolt, 9/16"-18 x 4.0", HHB, GB YZ	3
	Nut, 9/16"-18, Stover, G8, YZ	3
	Washer, 9/16", Flat, G8	6
48-2306	Sway Bar Drop Brackets	1
48-2307	Sway Bar Drop Brackets	1
48-2950	Hardware Pack, SB Drop Bracket	1
	Bolt, 7/16" - 14 x 1.25", G8Hex Head	4
	Washer, Flat, 7/16 Grade 8	8
	Nut, 7/16" - 14, Grade 8 Crimp Lock	4
48-2601	Brake Line Support Bracket - Front	2
48-2961	Hardware Pack, Brake Lines	1
	Bolt, 5/16" - 18 x 1", G8 Hex Head	4
	Washer, Flat, 5/16 Grade 8	8
	Nut, 5/16" - 18, Grade 8 Crimp Lock	4
	M6-1.0 - 16MM	2
	M6, Washer, Flat	2
	Zip Tie	6
48-2610	R. Brake Bracket	1
48-2621	R. E Brake Brackett	1
26-2505	5" Rear Blocks Pair Left and Right	1
	Set of 4 U-Bolts w/Nuts and Washers	1
44-2505	Front 7" Strut Spacers - Pair	1
	Nut, M10-1.25, Serrated Flange, 10.9	6
	Nut, M10-1.50, Serrated Flange, 10.9	6
93-2057R	Rear Shocks	2
48-2920	Lower Ball Joint Spacer (5mm Thick)	2

Safety Warning

Before you start installation:

ReadyLIFT® Off Road Suspension highly recommends that the installation of this product be performed by a professional mechanic with experience working on and installing suspension products. Professional knowledge and skill will typically yield the best installation results. If you need an installer in your area, please contact ReadyLIFT® Suspension customer service to find one of our "Pro-Grade" Dealers.

Notes:

- Installation by a professional mechanic is highly recommended.
- A Factory Ford Service Manual for your specific Year / Make / Model is highly recommended for reference during installation.
- Installation requires cutting and welding of the vehicle frame.
- Vehicles with a two piece rear driveline may require a carrier bearing drop support bracket, call technical assistance for details.
- Vehicles achieving more than 5" of rear lift may require rear driveline modifications, call technical assistance for details.
- All lifted vehicles may require additional driveline modifications and or balancing.
- A four wheel vehicle alignment will need to be performed after installation of this product.
- Speedometer / Computer recalibration is required if changing +/- 10% from factory tire diameter.
- Use of a Vehicle Hoist will greatly reduce installation time. Vehicle must be in excellent operating condition.
- Repair or replace any and all worn or damaged components prior to installation.



Installation Instructions 7" Lift Kit 2015 F150 4WD ONLY(44-2575)

Place the vehicle on level ground. Engage the parking brake and block the rear wheels for safety.

Record stock vehicle ride height measurements on both the front and the rear, this will provide a guideline on vehicle rake and lift height. Measure from the center of the wheel up to the bottom edge of the fender well opening and record on chart provided on page 2.

Disconnect the vehicle power source at the ground terminal on the battery using a 10mm socket.

*****2011 and newer models equipped with EPAS (Electronic Power Assist Steering), disconnect the power steering control module connector to avoid arching of the contacts in the internal power relay during disassembly and reassembly*****

You must Lock Steering Wheel in straight forward position with the column lock or steering wheel locking device.

*****Rotating the steering wheel while disconnected from the vehicle rack & pinion WILL cause damage to the steering column and /or internal clock spring.*****

1. Raise the front of the vehicle and support with jack stands at each frame rail behind the lower control arms. Remove the front wheels using a 13/16" socket.

2. Remove all factory skid plates and hardware using 13mm socket. Remove the plastic guard in between the two cross members of the frame by unclipping the plastic clips. Discard all.

(Fig 1 A, B)



Fig 1 A

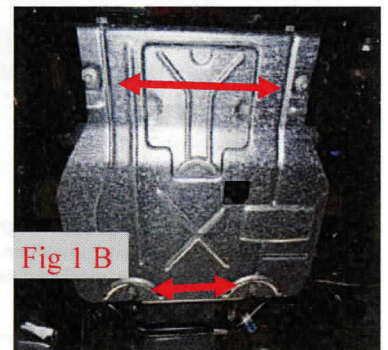

Fig 1 B

3. Remove the brake line brackets from the knuckle and frame using a 10mm. Remove the ABS line from the knuckle using a 8mm socket. Disconnect the vacuum line from the actuator on the backside of the knuckle. Repeat for driver and passenger sides.

(Fig 2 A, B, C)



Fig 2 A



Fig 2 B

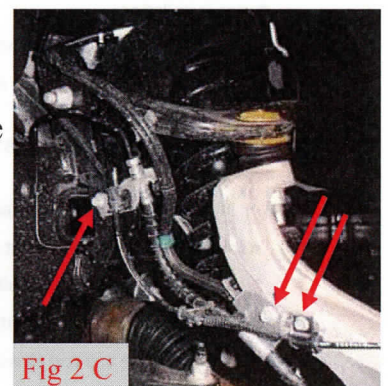

Fig 2 C



Installation Instructions 7" Lift Kit 2015 F150 4WD ONLY(44-2575)

Repeat for driver and passenger sides

4. Disconnect the ABS wires from the engine compartment and remove from brake line brackets. Unclip electrical connectors from plastic holders to gain slack for reassembly later.

(Fig 3 A, B)



Fig 3 A



Fig 3 B

5. Remove the tie rods from the knuckle using a 21mm socket. Strike the tie rod boss on the knuckle with a dead blow hammer to dislodge the taper from the knuckle.

(Fig 4)

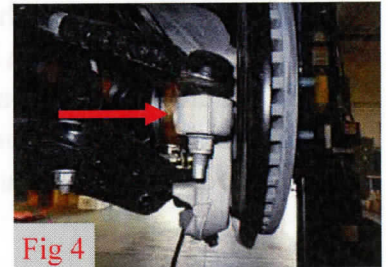

Fig 4

6. Remove the brake caliper anchor bracket bolts using a 21mm socket. Remove the caliper from the knuckle and hang the out of the way using a S - Hook or suitable strap. **DO NOT** let the caliper hang by the brake hose.

(Fig 5)

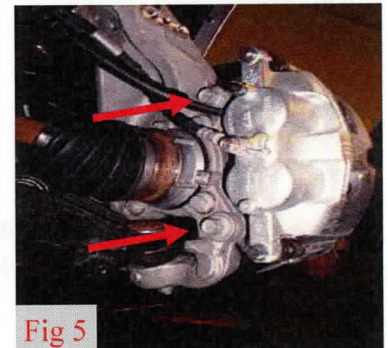

Fig 5

7. Remove the brake rotor and dust shield using an 8mm socket.

(Fig 6)

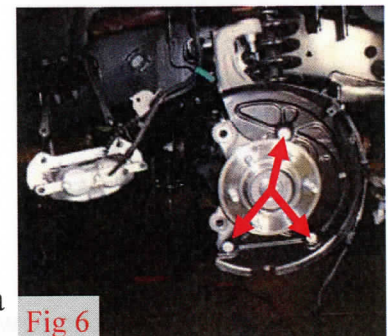

Fig 6

8. Remove the axle nut dust cover. Then remove the axle nut using a 15mm socket.

(Fig 7 A, B)

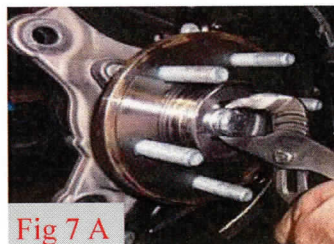

Fig 7 A

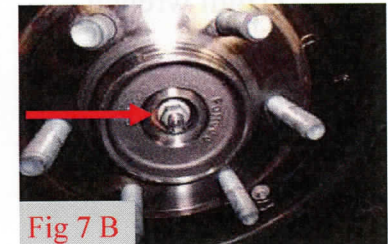

Fig 7 B



Installation Instructions 7" Lift Kit 2015 F150 4WD ONLY(44-2575)

Repeat for driver and passenger side

9. Loosen the upper ball joint nut using an 18mm socket. Strike the ball joint boss on the knuckle with a dead blow hammer to dislodge the taper. Remove the upper ball joint nut and separate the upper control arm ball joint from the knuckle. Using a 8mm socket remove the hardware holding the vacuum actuator on the knuckle and slide it and the axle to the side. Carefully remove the vacuum hub from the axle. **USE CAUTION TO NOT DAMAGE THE VACUUM ACTUATOR.**

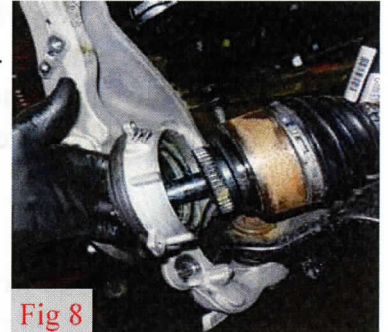

Fig 8

Loosen the lower ball joint nut using a 21mm socket. Strike the ball joint boss on the knuckle with a dead blow hammer to dislodge the taper and slide the knuckle off of the ball joint.

(Fig 8)

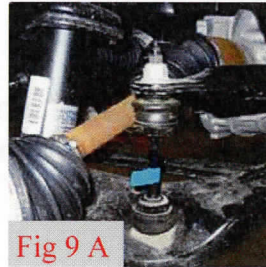

Fig 9 A

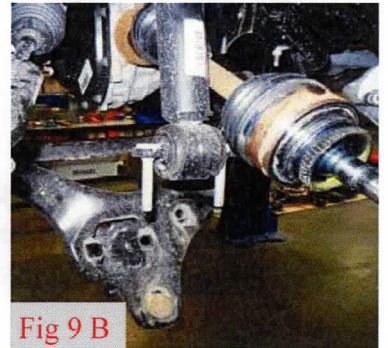

Fig 9 B

10. Remove the sway bar end link and strut from the lower control arm using 18mm socket.

(Fig 9 A, B)



Fig 10

11. Remove the lower control arms using a 27mm socket and 21mm wrench.

(Fig 10)

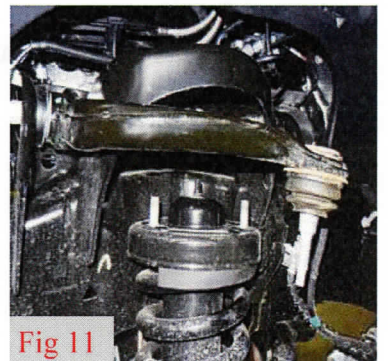

Fig 11



Installation Instructions 7" Lift Kit 2015 F150 4WD ONLY(44-2575)

Repeat for driver and passenger side

13. Remove the sway bar from the frame using a 15mm socket.
(Fig 12)



14. Remove the rear cross member from the frame using a 18mm socket and 15mm wrench. Discard cross member and driver side hardware. They will not be reused. Save passenger side hardware.
(Fig 13)

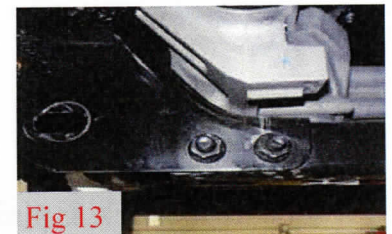

15. Mark driveshaft to differential location for reinstall later.
(Fig 14)



16. Remove the driveshaft mounting bolts using a 10mm socket. Remove from the front differential. Allow the driveshaft to rest out of the way.
(Fig 15)



17. Remove both the driver side and passenger side CV axle. Strike the shaft with a mallet or soft hammer to dislodge it from the c-clip. This step makes handling the differential much easier, but is not necessary.
(Fig 16)



*****Warning: The front differential is heavy and awkward. It is best removed by two people. Do not tilt the differential towards the opening on the driver side as gear oil will spill out.*****



Installation Instructions 7" Lift Kit 2015 F150 4WD ONLY(44-2575)

18. Support the differential with a suitable jack. Remove the vent tube. Remove the 3 differential mounting bolts from the frame using a 18mm socket and lower differential out of vehicle.
(Fig 17 A, B, C)

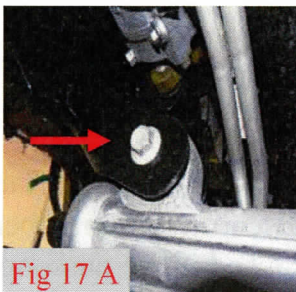

Fig 17 A

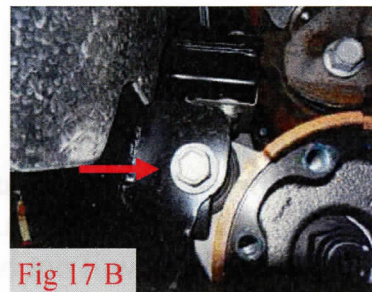

Fig 17 B

19. Locate the rack & pinion coupler pinch bolt. Mark the alignment of the rack and pinion input shaft and the coupler. Remove the pinch bolt using a 10mm socket and separate.
(Fig 17 C)

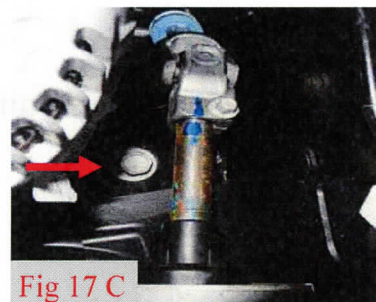

Fig 17 C

20. Disconnect the electrical leads to the rack and pinion.
(Fig 18)



Fig 18

21. With the rack supported, locate the two large bolts that hold the rack & pinion to the vehicle frame and remove using a 21mm and 24mm socket. Carefully lower the rack & pinion assembly from the vehicle.
(Fig 19)

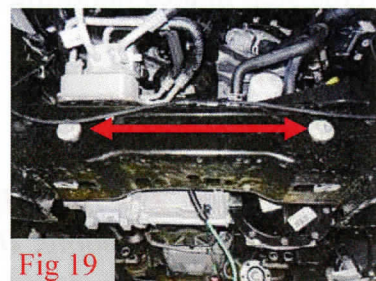

Fig 19



Installation Instructions 7" Lift Kit 2015 F150 4WD ONLY(44-2575)

Front Installation

22. The driver's side rear lower control arm frame pocket must be modified to provide clearance for the differential in its relocated position. On the front and back side of the frame pocket measure from the outside edge $2 \frac{5}{8}$ ". Mark a vertical cut line at the mark, all the way to the bottom. Connect the 2 lines across the top of the pocket. Using a suitable cutting tool, cut this pocket off the frame. Sand and paint exposed metal with quality rust preventative paint.

(Fig 20)

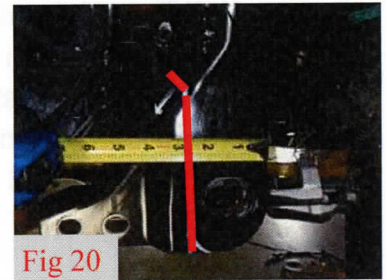

23. Locate the upper differential frame mount. Mark a line across the center of the mount. Make a cut to the frame. Cut the front half off the frame and sand flush with the frame. Paint exposed metal with quality rust preventative paint. This cut is for clearance of the steering shaft extension and u-joint.

(Fig 21)



24. Locate the driver side differential drop bracket **48-2300** and the **3/4" rod end**. Install the rod end into the pinch bung on the drop bracket. Set the distance from the edge of the pinch bung to the middle of the rod end to $1 \frac{3}{4}$ ". Set the rod end horizontal to the lower mounting bolt holes. Torque the pinch bung Allen bolt to **95 in-lbs** using $\frac{3}{16}$ " Allen tool.

(Fig 22)

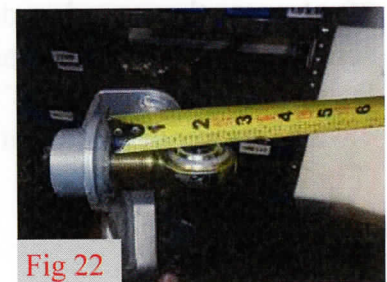

25. Install the completed driver side drop bracket into the factory location using the **14mm x 90mm** Allen bolt and **flat washer** from bag (48-2941). Do not tighten at this time.

(Fig 23)

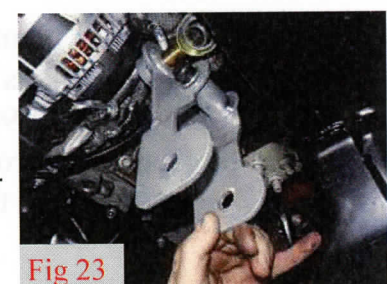

26. Locate passenger side differential drop bracket **48-2301** and install into the factory location using **factory bolt and capture nut**. Do not tighten at this time.

(Fig 24)

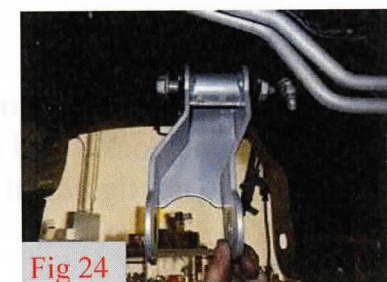



Installation Instructions 7" Lift Kit 2015 F150 4WD ONLY(44-2575)

27. Install differential onto the drop brackets using **2, 9/16" x 4" bolts**, and **2 washers** from bag **48-2941** from the front of the vehicle facing the rear. Do not install the 2nd washer and nut at this time. Rack and pinion shown for illustration purposes. Install vent tube extension from bag **48-2931** onto vent tube and differential.

(Fig 25 A, B)

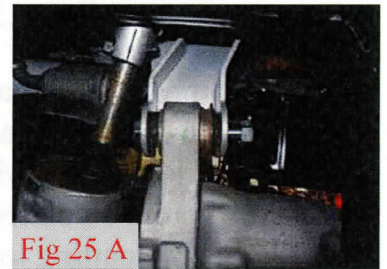

Fig 25 A

28. Locate passenger side differential brace **48-2305** and install onto passenger differential drop bracket. Install the **9/16" 2nd washers and c-nuts** from bag **48-2941** onto both driver and passenger side drop bolts. Do not tighten at this time.

(Fig 25 B)

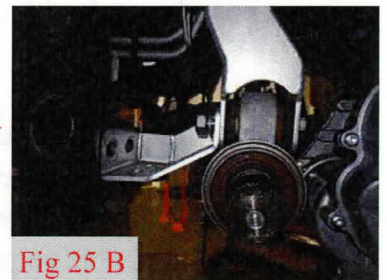

Fig 25 B

29. Locate the sway bar drop brackets, driver side **48-2306** and passenger side **48-2307**. Install brackets to corresponding sides of the frame using **7/16" x 1 1/4" bolts, flat washers, and c-nuts** from bag **48-2950**. Do not tighten at this time.

(Fig 26 A, B)



Fig 26 A

30. Locate rear cross member **48-2215** and install into the factory control arm frame pockets using **18mm x 150mm bolts, flat washers, and c-nuts** from bag **48-2905**. Go through the sway bar drop brackets and then the factory control arm frame pockets from the rear of the vehicle. Do not tighten at this time.

(Fig 26 A, B)



Fig 26 B

31. Install factory rear cross member bolts and nuts into the passenger side frame pocket and into passenger differential support bracket **48-2305**. Do not tighten at this time.

(Fig 27)

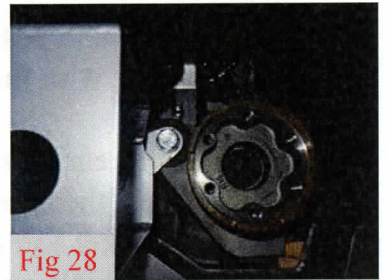

Fig 27



Installation Instructions 7" Lift Kit 2015 F150 4WD ONLY(44-2575)

32. Install rear differential mount using **9/16" x 4" bolt, flat washers, and c-nut** from bag **48-2941**. Do not tighten at this time.
(Fig 28)



33. Locate and install front cross member **48-2115** using the **factory control arm bolts and nuts** from the rear of the vehicle facing forward. Do not tighten at this time.
(Fig 29)



34. Locate the steering u-joint assembly **48-2303-2,48-2303-5**. Install the complete assembly onto the rack and pinion. Torque the u-joint Allen pinch bolt to **165 in-lbs**.
(Fig 30)

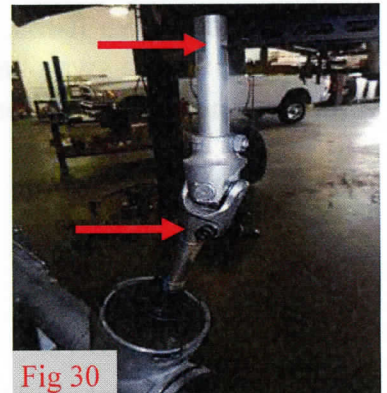

35. Install the rack and pinion unit onto the front cross member using the **factory bolts**, lining up the steering extension through the 3/4" rod end. Attach factory intermediate shaft to extension using **factory pinch bolt** and 10mm socket. Use a drop of Loctite on pinch bolt. Torque to **165 in-lbs**. Plug electrical connectors into rack and pinion. Front differential not shown for picture taking purposes. Do not tighten main bolts at this time.
(Fig 31 A, B, C)

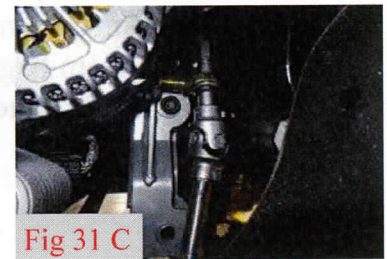
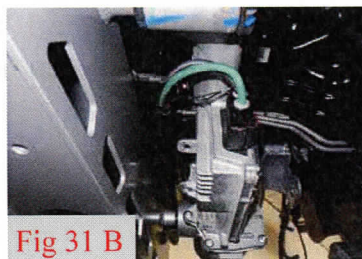



Installation Instructions 7" Lift Kit 2015 F150 4WD ONLY(44-2575)

36. Install driver and passenger axles at this time if removed by sliding them together with the differential until c-clip engages.

37. Install driver and passenger side lower control arms into corresponding sides of the cross members using **18mm x 140mm, flat washer, cam bracket and cam nut** from bag **48-2905**. Bolts facing to the ends of the vehicle and cam plates on the outside of the cross member. Do not tighten at this time.

(Fig 32)



38. Tighten all differential, rack and pinion, and cross member hardware at this time using 12mm Allen head tool, 5/8", 11/16", 15, 18, 21, 22, 24, 27mm sockets and wrenches. Starting with differential, torque all differential including the differential support to cross member hardware to **95 ft-lbs**, torque the cross member main hardware to **240 ft-lbs**, torque sway bar drop bracket hardware to **60 ft-lbs**, torque the rack and pinion to front cross member hardware to **150 ft-lbs**.

(Fig 33 A, B, C, D, E)

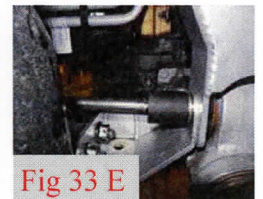
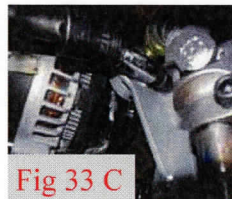
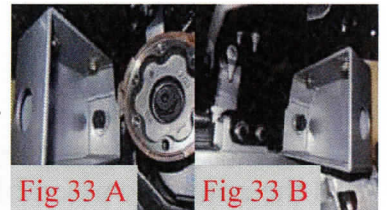

39. Install the front skid plate **48-2351** using **3/8" x 1"** hardware from bag **48-2937** and 9/16" socket. Torque to **35 ft-lbs**.

(Fig 34)

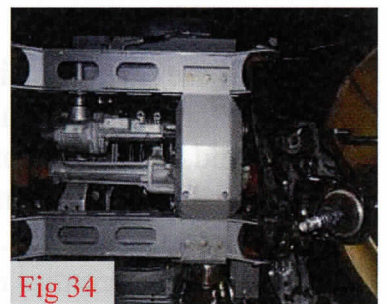

40. Install driveshaft spacer **48-2360** and driveshaft in the same orientation with the marks made in step 15 using the **10mm x 100mm Allen head bolts** from bag **48-2936** and 8mm Allen head tool. Apply Loctite to all bolts. Torque hardware to **76 ft-lbs**.

(Fig 35)





Installation Instructions 7" Lift Kit 2015 F150 4WD ONLY(44-2575)

Repeat for driver and passenger sides

50. Install the driver and passenger side strut spacers 44-2507 to their corresponding struts using supplied 10mm x 1.50 flange nuts and 14mm socket. They are marked D for drivers and P for passenger. Torque to 35 ft-lbs.

(Fig 36)



Fig 36

51. Install completed strut assemblies into vehicle frame and lower control arms in their corresponding locations using supplied 10mm x 1.25 flange nuts from 44-2507, factory lower hardware and 14, 18mm sockets. Torque upper nuts to 35 ft-lbs and lower nuts to 150 ft-lbs.

(Fig 37)



Fig 37

52. Locate driver knuckle 48-2402 and factory driver knuckle. Remove hub assembly using an 18mm socket. Inspect the mounting surface for any corrosion or dirt and clean as necessary. Install to aftermarket knuckle in the same orientation using factory hardware. Torque to 148 ft-lbs. Repeat procedure for the passenger knuckle 48-2403.

(Fig 38)



Fig 38

53. Locate the vacuum hub assembly and place onto the factory axle.

(Fig 39)



Fig 39

54. Install new knuckles onto the lower ball joints using factory ball joint nut, 3/4" thick washer from bag 48-2920 and 21mm socket. Run tight at this time. Will torque in later step.

(Fig 40 A, B, C)



Fig 40 A



Fig 40 B



Fig 40 C



Installation Instructions 7" Lift Kit 2015 F150 4WD ONLY(44-2575)

***** Important*** Read and understand following steps. Failure to do so may result in broken or damaged vacuum actuator.*****

Repeat for driver and passenger side

55. Raise knuckle towards upper control arm while guiding the axle shaft into the hub assembly. Take vacuum actuator and move to knuckle mounting surface making sure to engage the splined inner ring to the hub assembly and that the vacuum ports are pointing to the top of the knuckle. Once engaged to splines, install upper ball joint to knuckle using **factory ball joint nut**. Leave loose at this time. Install vacuum actuator using **factory hardware** and 8mm socket. Torque to **5 ft-lbs**. Grab axle and pull towards the hub assembly while rotating the hub to engage the splines of the axle with the vacuum actuator. Once the splines have been engaged, install **factory axle nut** using 15mm socket. Torque to **18 ft-lbs**. You will be able to tell if the axle has been fully engaged to vacuum actuator and hub assembly when the shoulder of the axle is visible through the hub and when rotating hub assembly the axle will rotate also. The shoulder should be 2mm under the nut mounting surface. If this is not the case, then the hub assembly will need to be rotated more until full engagement of splines. These steps are very important to follow. The vacuum actuator is made of plastic and is very easily damaged. Repeat steps for driver and passenger sides.

(Fig 41 A, B, C, D)

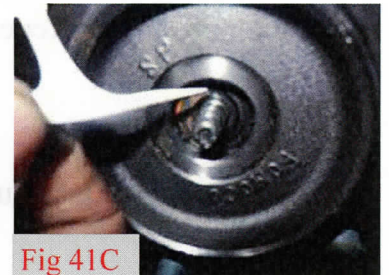

56. Install the ABS sensor onto the hub assembly using **factory Allen bolt hardware** and 5mm Allen tool. Torque to **5 ft-lbs**. Repeat for driver and passenger sides

(Fig 42)



57. Install dust shield to knuckle using **factory hardware** and 8mm socket. Torque to **5 ft-lbs**. Repeat for driver and passenger sides.

(Fig 43)





Installation Instructions 7" Lift Kit 2015 F150 4WD ONLY(44-2575)

Repeat for driver and passenger side

58. Install rotor and brake caliper assembly to hub assembly and knuckle using **factory hardware** and 21mm socket. Apply a drop of Loctite to threads and torque to **148 ft-lbs.**

(Fig 44 A, B)



Fig 44 A

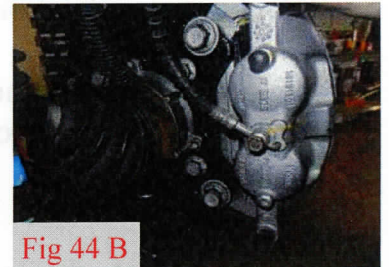

Fig 44 B

59. Install brake line bracket to knuckle using **6mm x 16mm** from bag **48-2961** and 10mm socket. Install ABS wire to knuckle using **factory hardware** and 8mm socket. Torque all **10 ft-lbs.** Install vacuum lines to vacuum actuator.

(Fig 45)



Fig 45

60. Install front brake line drop bracket **48-2601** to factory hard line bracket using **5/16" x 1" bolts, flat washers, and c-nuts** from bag **48-2961** and 1/2" socket and wrench. Gently pull down and bend the metal brake line at the frame to be able to attach the brake line drop bracket to the factory location using the **factory hardware** and 10mm socket. Torque all brake line bolts to **10 ft-lbs.**

(Fig 46 A, B)

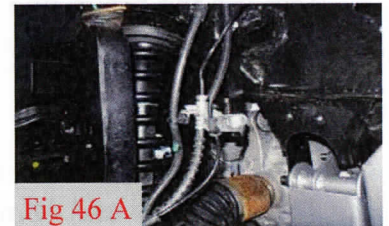

Fig 46 A

61. Attach ABS wire to factory locations on factory brake line brackets. Run the ABS line on the outside of the strut tower next to the vacuum lines at strut tower location, attach to the frame with a zip tie through the upper control arm pocket. Reattach electrical connectors in engine compartment.

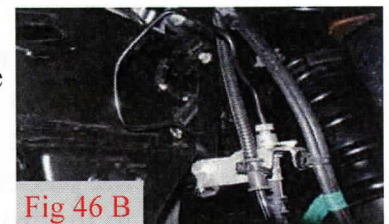

Fig 46 B

62. Install outer tie rod ends to knuckle using **factory hardware** and 21mm socket. Torque tie rod end nut and lower ball joint nut to **110 ft-lbs.** Torque the upper ball joint nut to **85 ft-lbs.**

63. Install sway bar to drop brackets using **factory hardware** and 15mm socket. Torque to **35 ft-lbs.** Install end links to lower control arm using **factory hardware** and 18mm socket. Torque to **40 ft-lbs.**

(Fig 47)



Fig 47



Installation Instructions 7" Lift Kit 2015 F150 4WD ONLY(44-2575)

64. Install the wheels and tires and lower the vehicle to the ground. Torque lug nuts to wheel manufacturer specifications.
65. Jounce the front of the vehicle to settle the front suspension. Move the lower control arm eccentric cams to full inboard. Torque to **150 ft-lbs**.

Rear Install

1. Block the front wheels and raise the rear of the vehicle. Place jack stands under the frame rails ahead of the spring hangers.

2. Remove the rear wheels.

3. Remove the rear emergency brake line bracket from the frame ahead of the driver side spring using a 8mm socket.

(Fig 1)

4. Remove the brake line bracket from the frame using a 10mm socket.

(Fig 2)

5. Support rear axle with a suitable jack and remove the shocks using 15mm socket and 18mm wrench. Discard shocks as they will not be reused.

6. Slightly loosen but do not remove the driver side u-bolts. Remove the passenger side u-bolts completely and discard. Lower the axle just enough to remove the factory blocks and install the lift blocks **26-2505**. Locate the passenger side lift block, making sure the tapered end points to the front and the bump pad is facing the inside of the vehicle. Install the lift block on the axle pad aligning the pins. Raise the axle and the block up to the spring while aligning the center pins. Install the provided **u-bolts, washers and nuts**. Snug the u-bolt nuts but do not fully tighten at this time. Repeat steps for driver side.

(Fig 3, 4)

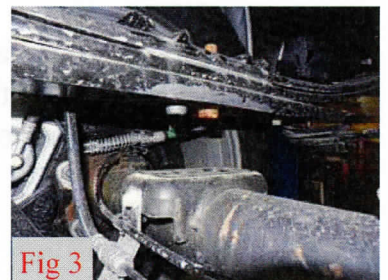
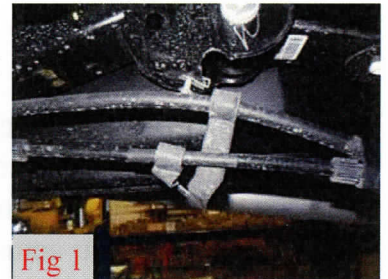



Installation Instructions 7" Lift Kit 2015 F150 4WD ONLY(44-2575)

8. Install the rear brake line drop bracket **48-2610** to the frame using **factory hardware** and 10mm socket. Gently pull the rear hard lines down and attach the rear brake line bracket to the drop bracket using **5/16" x 1" bolt, washers, and c-nut** from bag **48-2961**. Torque all to **10 ft-lbs.**

(Fig 4)



9. Install the rear emergency brake line drop bracket **48-2621** to the frame using the **factory hardware** and 10mm socket, the emergency brake line bracket to the drop bracket using **5/16" x 1" bolt, washers and c-nut** using 1/2" socket and wrench. Torque to **10 ft-lbs.**

(Fig 5)

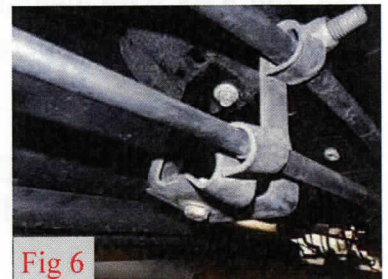

10. Install rear wheels and lower vehicle to the ground. Torque lug nuts to wheel manufacturers specifications.

11. Jounce vehicle to settle suspension. Torque rear u-bolts to **125 ft-lbs.**

Final install and checks

Recheck that all hardware is of proper torque values and all electrical connections are hooked up. Start vehicle and verify that all dash warning lights are off. Cycle the steering wheel from lock to lock to check for any interference of steering intermediate shaft, steering extension, steering u-joint. wheels, tires, brake lines, hoses, wires, ect and ensure adequate clearance through out the suspension cycle. Adjust as necessary.

*** Due to manufacturer frame variances, if there is any contact between steering extension, u-joint or intermediate shaft, it may be necessary to remove extension from intermediate shaft and u-joint to adjust rod end in to gain clearance.*** If driving vehicle to an alignment shop, adjust toe prior to vehicle operation.

Install all warning tags and decals as directed:

1. Rear view mirror hanging warning card: Hang from rear view mirror to warn driver of vehicle modification.
2. Lifted truck warning decal: Apply decal to the upper left hand corner of the inside of the windshield facing the driver.

Give all installation instructions, warranty information, and all remaining literature to the end user to keep with vehicle records.



Installation Instructions 7" Lift Kit 2015 F150 4WD ONLY(44-2575)

Final Checks & Adjustments

Post Installation Warnings: Once the vehicle is lowered to the ground, check all parts which have rubber or urethane components to insure proper torque. Torque wheels to factory specs. Move vehicle backwards and forwards a short distance to allow suspension components to adjust. Turn the front wheels completely left then right and verify adequate tire, wheel, brake line, and ABS wire clearance. Test and inspect steering, brake and suspension components for tightness and proper operation. Inspect brakes hoses and ABS lines for adequate slack at full extension.

*****FAILURE TO PERFORM THE POST INSPECTION CHECKS MAY RESULT IN VEHICLE COMPONENT DAMAGE AND/OR PERSONAL INJURY OR DEATH TO THE DRIVER AND/OR OTHERS*****

Vehicle Handling Warning: Vehicles with larger tires and wheels will handle differently than stock vehicles. Take time to familiarize yourself with the handling of your vehicle.

Wheel Alignment/Headlamp Adjustment:

It is necessary to have a proper and professional wheel alignment performed by a certified alignment technician. Align the vehicle to factory specifications. It is recommended that your vehicle alignment be checked after any off-road driving. In addition to your vehicle alignment, for your safety and others, it is necessary to check and adjust your vehicle headlamps for proper aim and alignment

Vehicle Re-Torque and Safety Inspection:

Upon completion of all services and adjustments performed on your vehicle, and within 50 miles of driving, check to ensure all fasteners and hardware are properly torqued to specification as noted in the vehicles factory service manual or the torque chart included.

*****RECHECK ALL HARDWARE FOR PROPER TORQUE VALUES AFTER 500 MILES, AND THEN PERIODICALLY AT THE EACH SERVICE INTERVAL THERAFTER.*****

Recommended Alignment Specs

Camber	-0.3	-0.3	Tolerance	+/- 0.5
Caster	+3.5	+3.5	Tolerance	+/- 0.5
Toe	+1.0	+1.0	Total	+20