

ADDICTIVE DESERT DESIGNS

2015 - Current Ford F150 Race Series R Front Bumper Installation Instructions

PREPARATION STEPS

1. Disconnect the negative terminal on the battery. Park the vehicle on level ground and set the emergency brake.
2. We recommend reading through the installation instructions in whole before performing the work.
3. You will need the following tools:
 - a. 3/4" Socket and Wrench
 - b. 13/16" Socket
 - c. 15mm Socket
 - d. 7mm Socket
 - e. 5.5mm Socket
 - f. Ratchet
 - g. Utility Knife
 - h. Reciprocating Saw

Note: This installation requires 2 people for best results

4. Included in Kit:
 - 6 – 1/2"-13 x 1 1/2" Hex Head Bolt
 - 12 – 1/2" SAE Flat Washers
 - 6 – 1/2"-13 Nylon Lock Nut

OEM REMOVAL INSTRUCTIONS

1. From the bottom of the truck, remove any fog light connectors, if your truck is equipped with fog lights, and move the wiring harness out of the way.
2. From the top, remove the 3 plastic clips that are holding the rubber shroud to the top of the front bumper. The locations of where these 3 clips attach to the front bumper have been marked in Fig A.

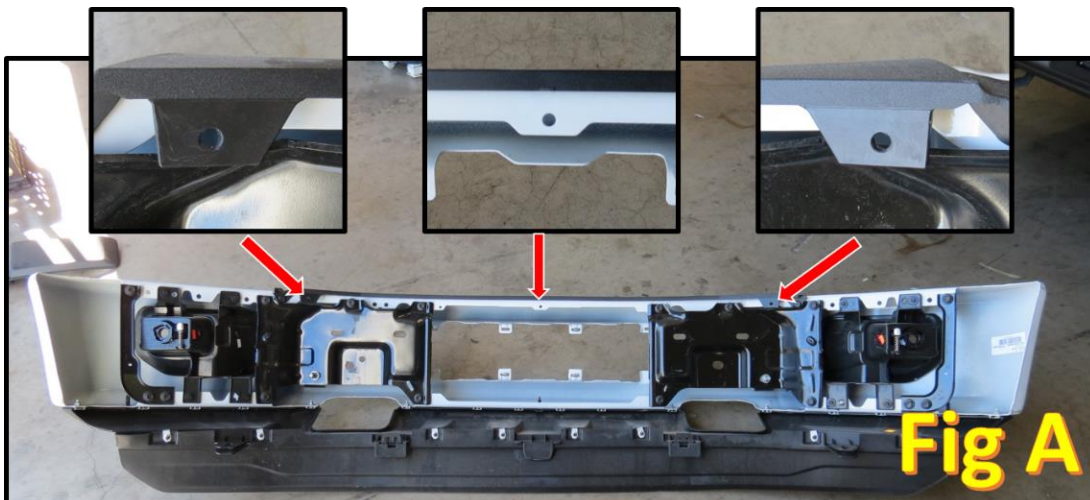

- Carefully remove the front plastic piece from the bumper. There are no tools required for this, it can be pulled off by hand.



- From the bottom, remove the 13/16" nuts/bolts (x2) holding the bumper mount to the front frame horns. There is one per side. The location of these nuts is marked in Fig C.

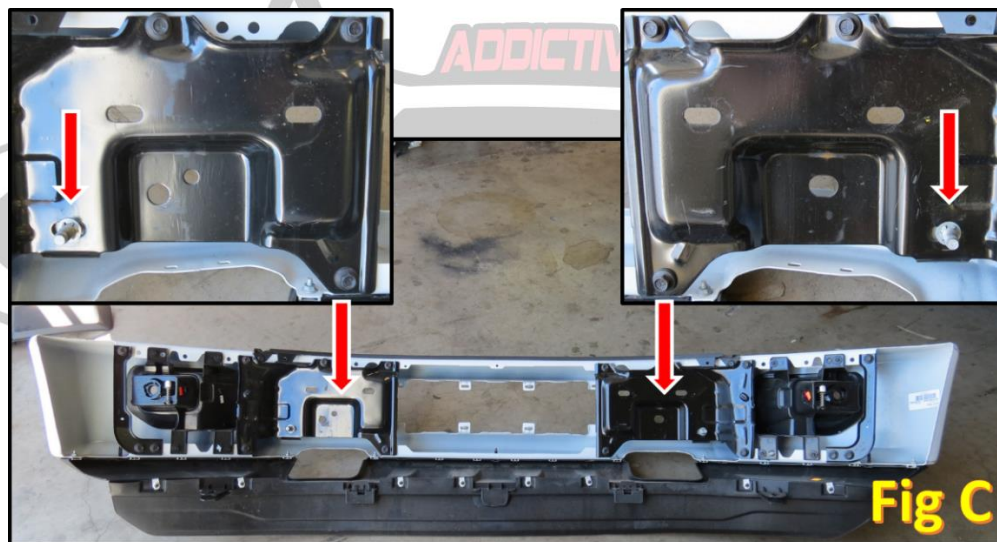

- From the top, remove the remaining 13/16" nuts/bolts (x4) that were behind the plastic covers removed in Step 2. There are 2 per side. The location of these nuts is marked in Fig D.

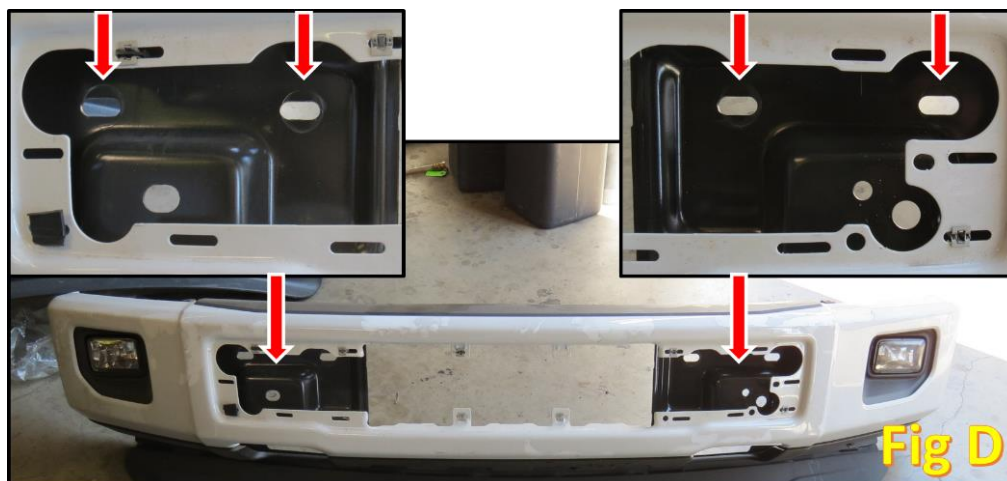

- Carefully slide the bumper out towards you and off the vehicle.
- Remove the plastic clip on the top of the headlight bezel. Refer to Fig E.



- Remove the two 7mm bolts farthest forward on the OEM fender flare. Refer to Fig F.
- Gently pull the fender flare out towards you until it unclips from the headlight bezel. Refer to Fig G.

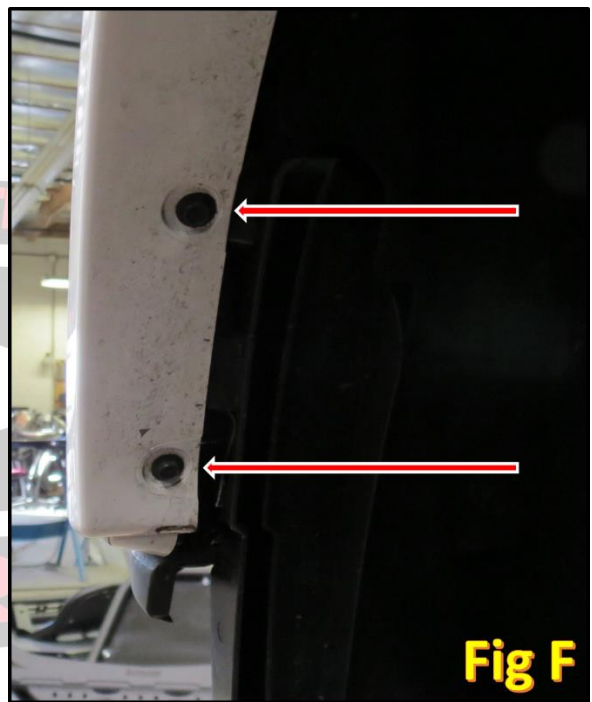

- Gently pull the headlight bezel forward and off of the vehicle. Refer to Fig H



- Remove the two 5.5mm bolts on the front side of the inner fender liner that are referenced in Fig I



12. Remove the 3 bolts referenced in Fig J on the air dam that sits behind the headlight bezel.



13. Undo the two clips referenced in Fig K, and pull the bottom portion of the air dam off the vehicle.



14. Push the headlight bezel back on the vehicle and reinstall the plastic clip that was removed in Step 7. Reinstall the bolts that were removed in Step 8.

15. Using a reciprocating saw, cut off the crash bar that sticks out right in front of your tires. Refer to Fig L. Make sure to paint over any bare metal to avoid rust issues.



16. Using a utility knife, trim the inner fender liner that hangs down where the air dam used to be. Refer to Fig M

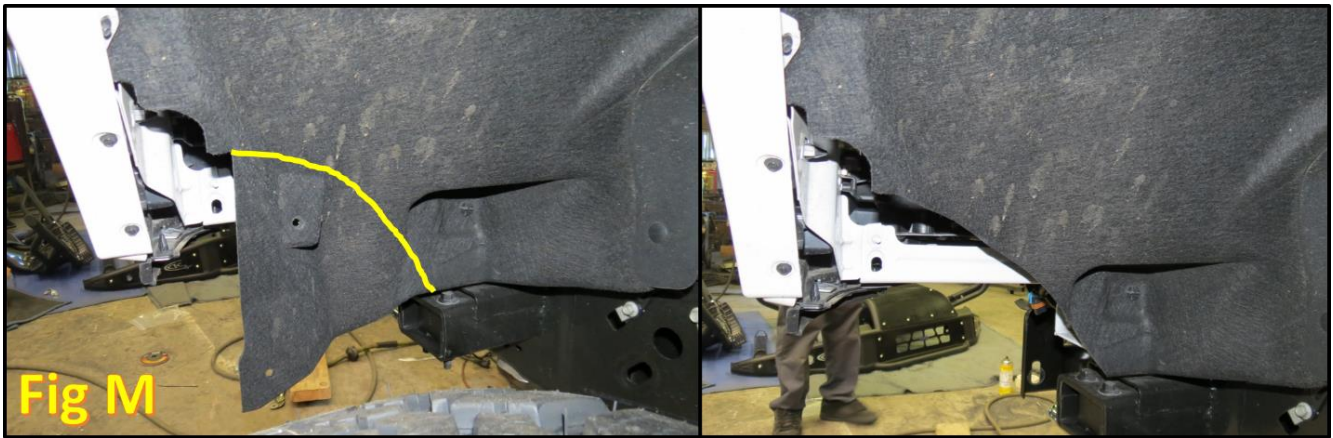

17. Remove the two plastic clips that hold on the rubber piece shown in Fig M. The clip locations are referenced in Fig N.

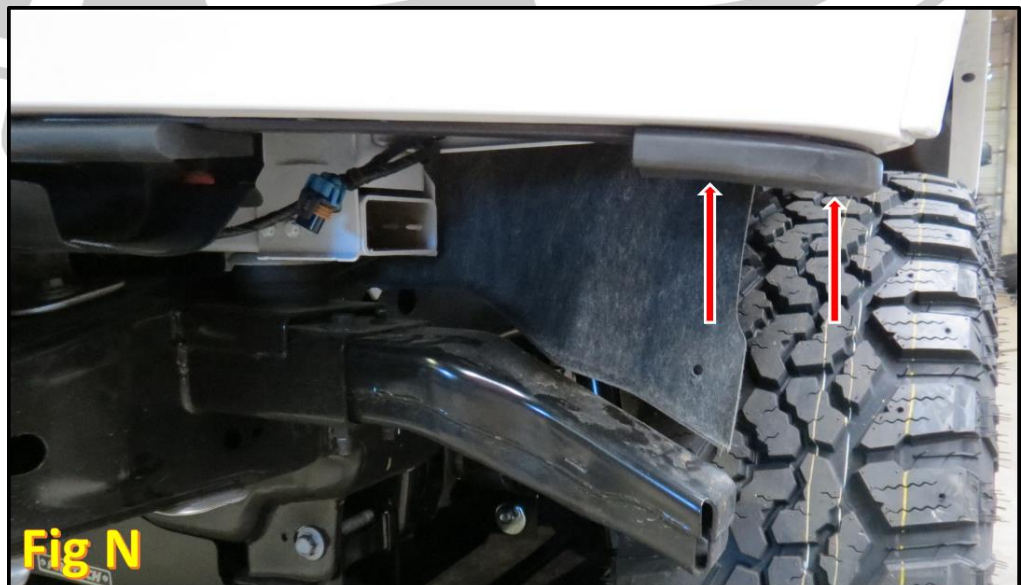

18. If desired, you can remove the rubber shroud that sits between the radiator and the intercooler. To do this, remove the accessible clips on the outside portions of this piece, then use a utility knife to cut it out as far back as possible. Refer to Fig O.

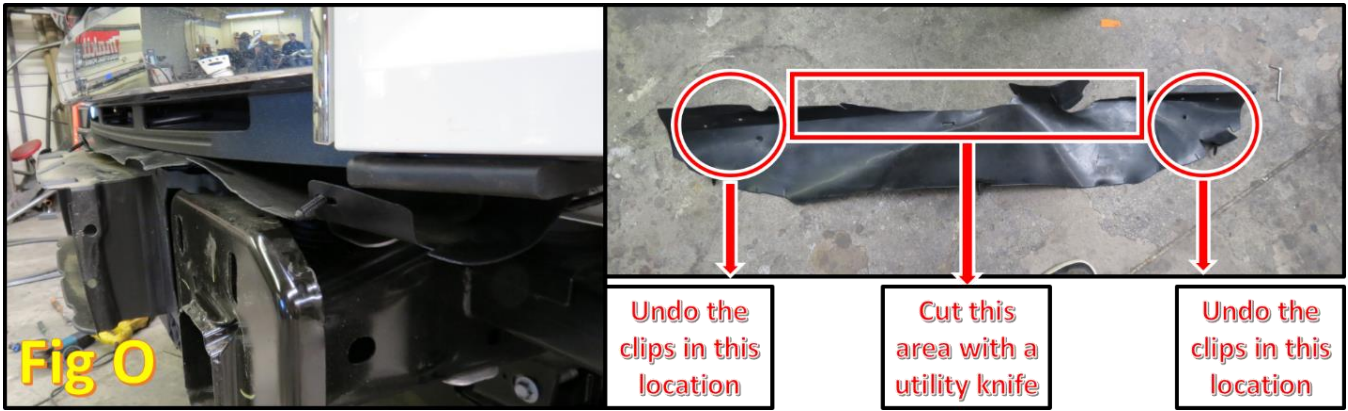

19. Prepare to install your new A.D.D. Front Bumper.

INSTALLATION INSTRUCTIONS

1. If you have purchased any lights/light mounting kits with your bumper, now would be a good time to install those. Please follow the light manufacturer's installation instructions for wiring information.
2. Mount your A.D.D. bumper to your truck.
 - a. Line the holes on the mounting tabs of the A.D.D. Bumper with the mounting holes on the frame horns of the truck. Use the supplied 1/2x1 1/2" bolts (x6), 1/2" Washers (x12), and 1/2" locking nuts (x6) to hold the bumper in place. Install them finger tight until they are all on. (Fig P)
 - b. Before giving the bolts a final torque, line the bumper up with the grill/valance to make sure everything is straight (This is where a second person might come in handy).
 - c. Once the bumper is properly aligned, tighten the 1/2" mounting bolts to 70 foot pounds.



3. Stand back and enjoy your A.D.D. Race Series R Front Bumper.
4. Check and re-tighten if needed, all mounting bolts after 100 miles and periodically thereafter.



For Additional Support or Technical Questions,
Please Call 480.671.0820 or
Email info@addictivedesertdesigns.com

Addictive Desert Designs
4840 E. Jasmine Street Suite 112
Mesa, AZ 85205
www.addictivedesertdesigns.com
www.addictivedesertdesigns.com