

ADDICTIVE DESERT DESIGNS

2017 – Current Ford Raptor HoneyBadger Rear Bumper Installation Instructions

PREPARATION

1. Disconnect the negative terminal on the battery. Park the vehicle on level ground and set the emergency brake.
2. We recommend reading through the installation instructions in whole before performing the work.
3. Estimated Installation Time: **2 Hours**
4. You will need the following tools:

- a. Ratchet
- b. 9/16" Socket and Wrench
- c. 7/32" Allen Wrench or Allen Key Socket
- d. T40 Torx Socket
- e. 15mm Socket
- f. 10mm Socket
- g. 13/16" Socket
- h. Grinder
- i. Paint

Note: this installation requires 2 people for best results

5. Included in Kit:

- 4** – Hex Head Bolts – 3/8"-16 x 1 1/2"
- 2** – Button Head Bolts – 3/8"-16 x 1"
- 10** – Flat Washers – 3/8"
- 6** – Nylon Locking Nuts – 3/8"-16

REMOVAL

1. Unplug the electrical connector on the back of your trailer light plug, then remove the plug by pushing in the two tabs and pulling it out the front of the bumper. (Fig A)



Fig A

2. Take off your license plate.
3. Remove your license plate lights from their housing.
4. Remove the parking sensors (x4) from their outer mounting rings. Simply spread the two tabs on the back of the mounting ring to allow the sensors to push out the back of the ring. Leave the mounting rings in the bumper for now. (Fig B)



5. Carefully pull the plastic center piece of the bumper off. There are no tools required for this step, it pulls off by hand. (Fig C)



6. Using a T40 Torx Bit, remove the bolts (x5) holding on each metal side piece. (Fig D)



7. Remove the plastic clips (that hold the parking sensor harness in place) from the metal bumper ends, then remove the metal bumper ends from the truck. (Fig E)

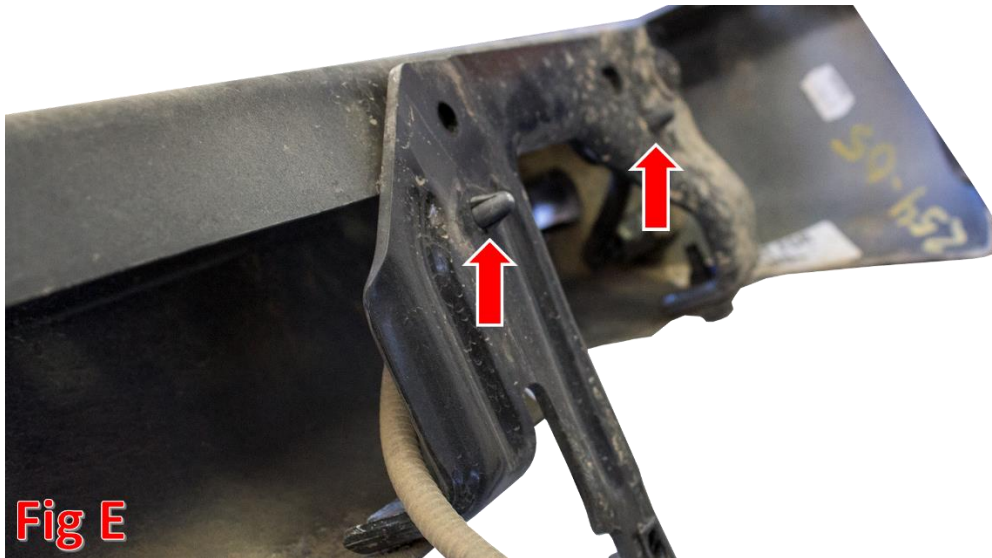

8. Grind the five welds to remove the license plate structure from the rear frame. Make sure to paint over any bare metal when you're done grinding. (Fig F)

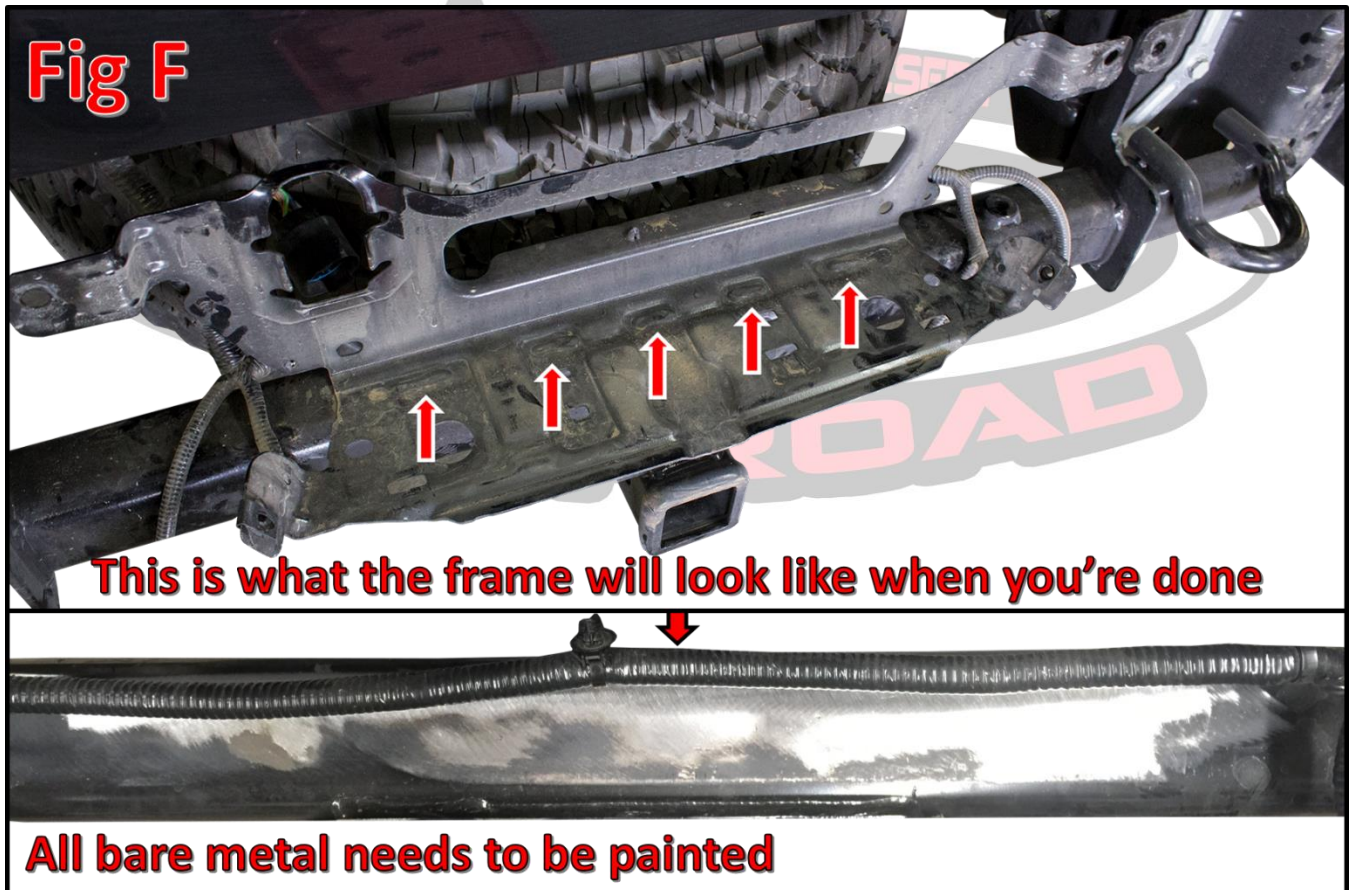

9. Using a 15mm Socket, remove the bolt that holds the strap to the bottom of the hitch tube. Save this bolt for reuse. (Fig G)



Fig G

10. Using a 10mm Socket, remove the nuts (2 per side) that hold the exhaust to the hitch assembly. Save these nuts for reuse. (Fig H)

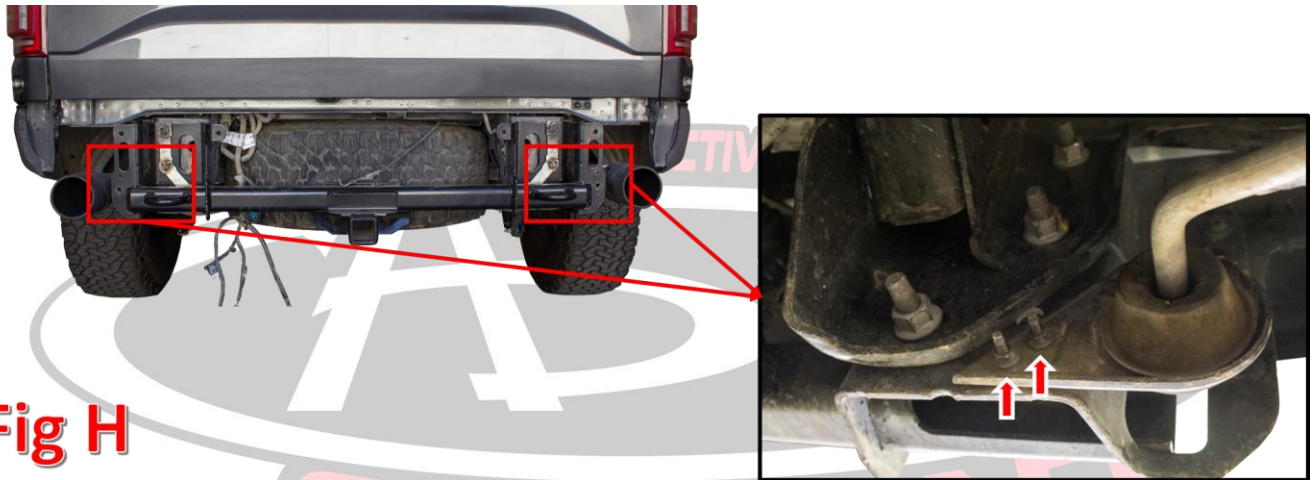

Fig H

11. Using a 13/16" Socket, remove the mounting bolts (x6) that hold the hitch assembly on the vehicle. Then, remove the hitch assembly from the vehicle. Save these nuts for reuse. (Fig I)

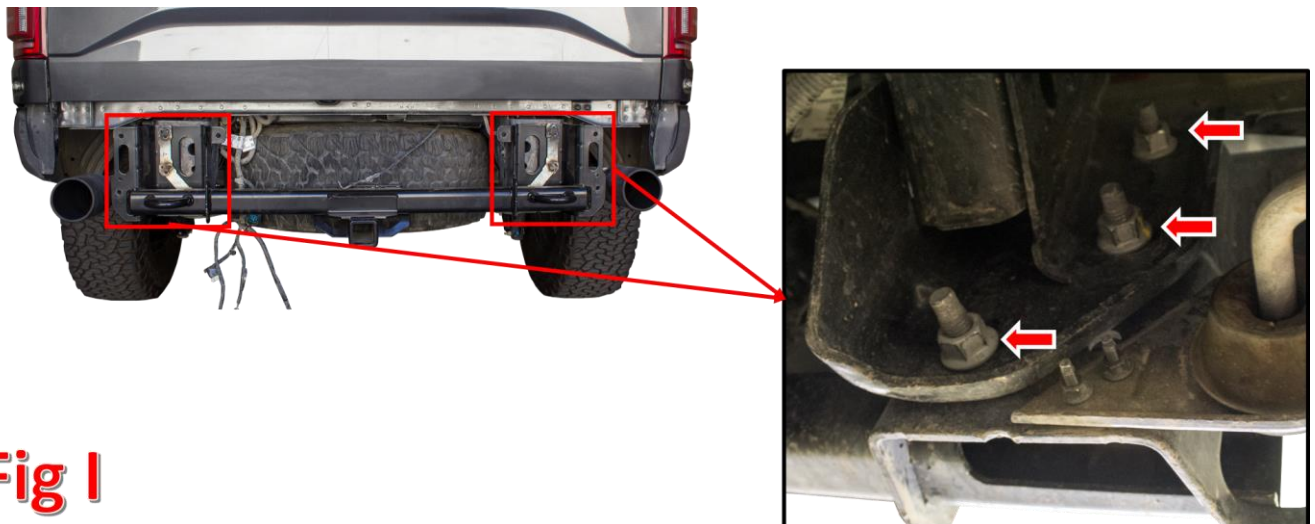

Fig I

12. Remove the parking sensor mounting rings from the OEM bumper. Do this by pressing in the two tabs on the back of the ring and pushing them out the front of the bumper.

13. Remove the license plate light housings from the OEM bumper. Do this by pressing in the two tabs on the back of the housings and pushing them out the front of the bumper.
14. Prepare to install your new ADD HoneyBadger Rear Bumper.

INSTALLATION

1. If you purchased lights for your bumper, now is a good time to install them. Follow the light manufacturer's installation instructions for mounting and wiring information.
2. Install the parking sensor mounting rings onto your new bumper by simply pressing them into their precut holes. If the rings do not click into place, you may have to trim the tabs on the side of the rings. Refer to Fig J for trimming information.
3. Install the license plate light housings on your new bumper by simply pressing them into their precut holes until they click in place. (Fig K)

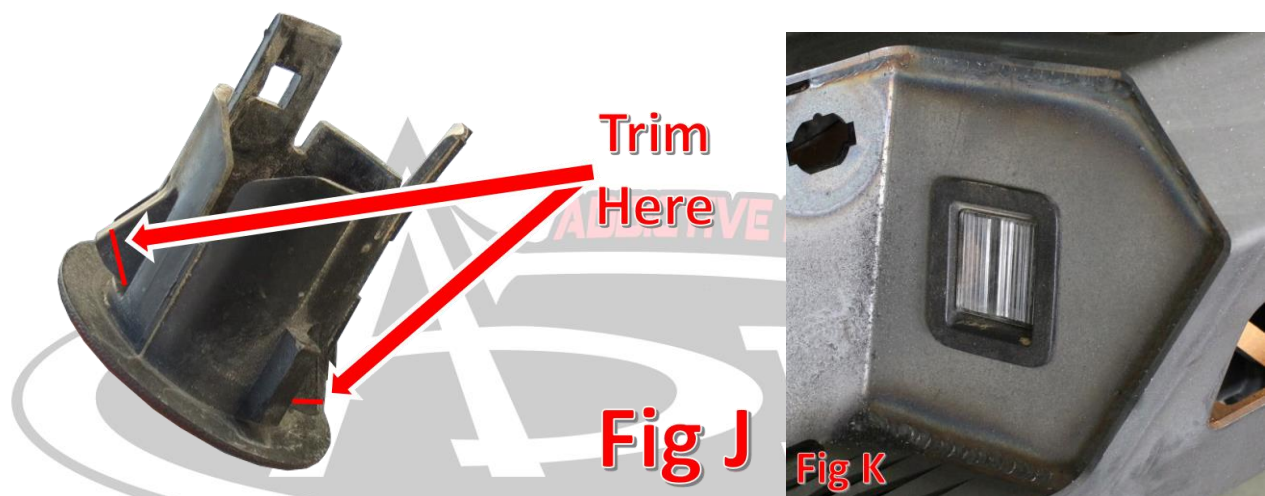

4. Install the trailer plug relocation bracket. Use the supplied 3/8" Button Head Bolts (x2), 3/8" Washers (x2), and 3/8" Locking Nuts (x2) to secure the bracket to your bumper through the predrilled holes. (Fig L)

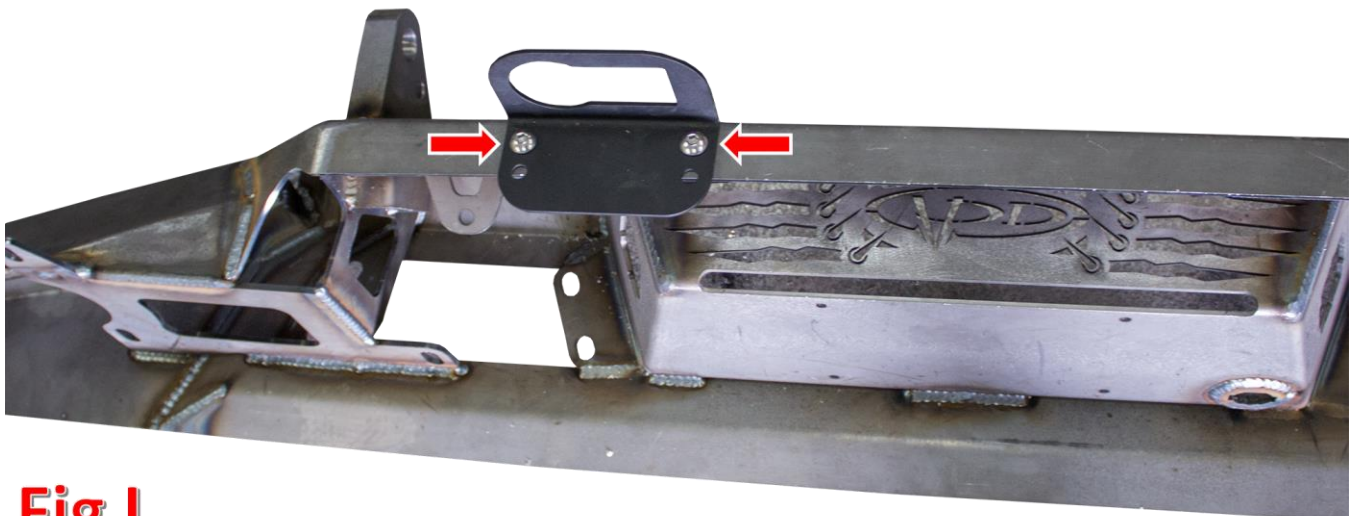

5. Line the mounting holes on the bumper up with the mounting holes on the hitch assembly. Loosely mount the bumper to the hitch assembly using the supplied 3/8" Hex Head Bolts (x4), 3/8" Washers

(x8), and 3/8" Lock Nuts (x4). Use two of the OEM Bolts for the bottom mounting holes. **Leave all these bolts finger tight for now.** (Fig M)



Fig M

6. Reinstall the hitch assembly with the rear bumper attached to it. Reuse the OEM hardware you set aside in Removal Step 11. **Leave these bolts loose for now.** (Fig N)

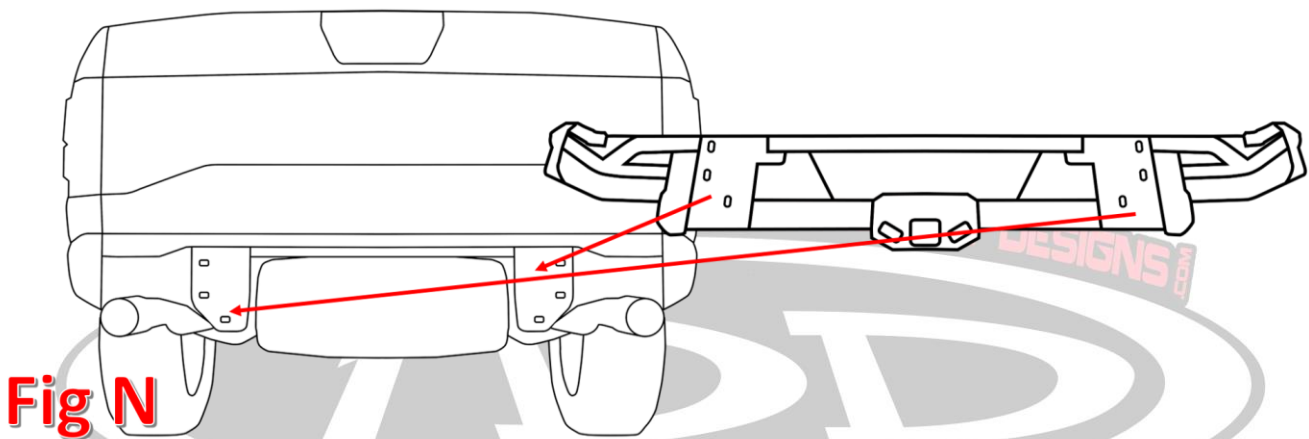

Fig N

7. Center the bumper left to right, then tighten the 3/8" Bumper Mounting Bolts to 45 foot pounds. Torque the lower bumper mounting bolts to OEM torque spec.
8. Adjust the trailer hitch up and down until the bumper sits straight in relation to the tailgate. Then, torque the trailer hitch mounting bolts to the manufacturer's torque spec.
9. Install the parking sensors by pressing them into the back of their mounting rings.
10. Install the license plate lights by twisting them into their housings.
11. Install the trailer plug by pressing it into the precut hole in its mounting bracket. Then, plug the electrical connector into the back of the plug. You will have to undo the first plastic clip on the trailer plug harness for the connector to reach the back of the plug.
12. Install your license plate.
13. Reinstall the strap you removed in Removal Step 9. Do this by holding the strap in place and reinstalling the OEM bolt. Torque this bolt to the manufacturer's torque spec.
14. Reinstall your exhaust brackets. Do this by reinstalling the OEM nuts (x4) you removed in Removal Step 10. When you install the nuts, leave them finger tight. Then, set your exhaust height. While holding the exhaust pipes at their desired heights, tighten the OEM hardware to the manufacturer's torque specification.
15. Stand back and enjoy your new ADD HoneyBadger Rear Bumper.
16. Check and re-tighten if needed, all mounting bolts after 100 miles and periodically thereafter.



For Additional Support or Technical Questions,
Please Call 480.671.0820 or
Email info@addictivedesertdesigns.com