

ADDICTIVE DESERT DESIGNS

2017 – Current Ford Raptor Stealth Fighter Front Bumper Installation Instructions

PREPARATION

1. Disconnect the negative terminal on the battery. Park the vehicle on level ground and set the emergency brake.
2. We recommend reading through the installation instructions in whole before performing the work.
3. Estimated Installation Time: **2 Hours**
4. You will need the following tools:
 - a. Ratchet
 - b. 3/4" Socket and Wrench
 - c. 9/16" Socket
 - d. E6 External Torx Socket
 - e. 8mm Socket
 - f. 11mm Socket
 - g. 13mm Socket
 - h. 15mm Socket
 - i. 21mm Socket
 - j. Reciprocating Saw

Note: this installation requires 2 people for best results

5. Included in Kit:
 - 4 – Hex Head Bolts – 1/2"-13 x 1 1/2"
 - 6 – Flat Washers – 1/2"
 - 2 – Nylon Locking Nuts – 1/2"-13
 - 2 – U-Nuts – 1/2"-13
 - 2 – Hex Head Bolts – 3/8"-16 x 1 1/2"
 - 4 – Flat Washers – 3/8"
 - 2 – U-Nuts – 3/8"-16

REMOVAL

1. Use 13mm and 15mm Sockets to remove the skid plate bolts (x6), then remove the skid plate from the truck. (Fig A)

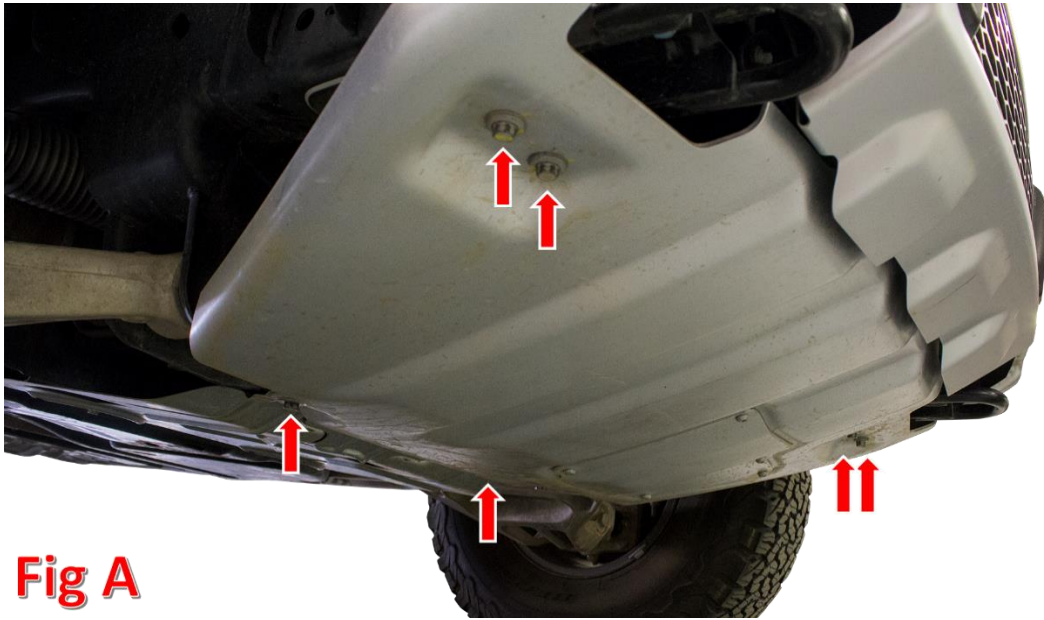


Fig A

2. Remove the metal spacer that the bottom two skid plate bolts go through. Then, remove the two factory U-nuts that the bottom two skid plate bolts threaded into. (Fig B)

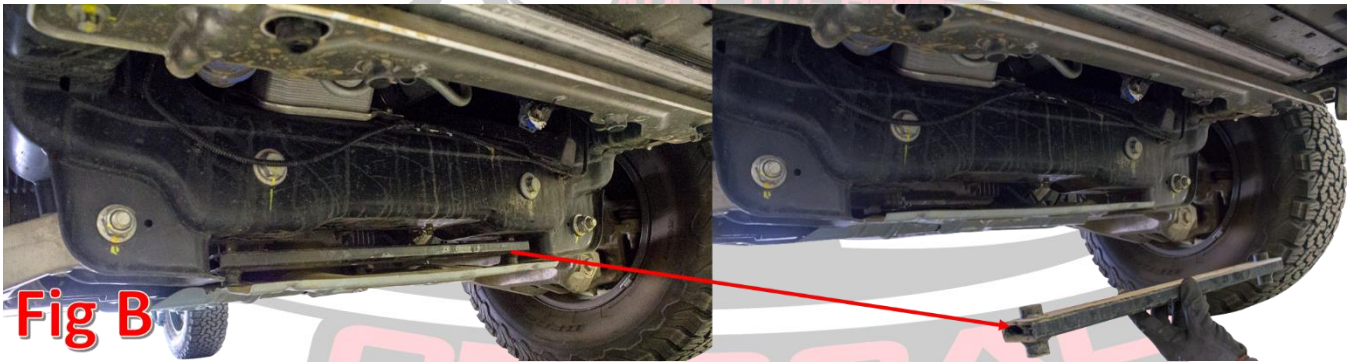


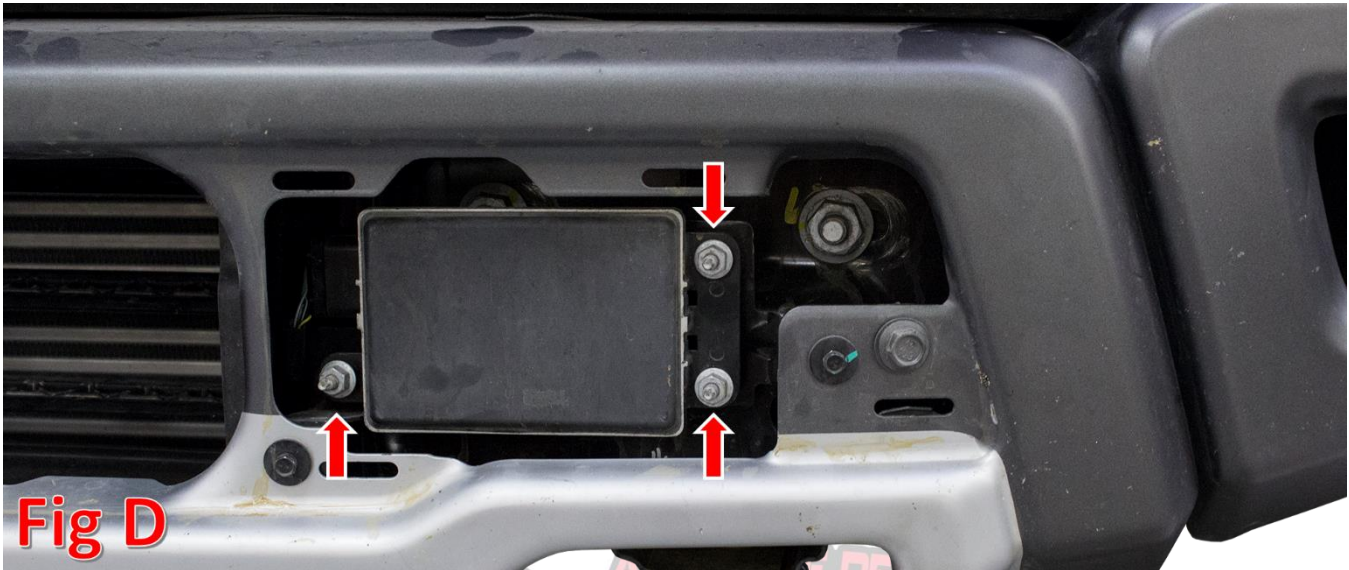
Fig B

3. Carefully pull the front plastic piece off of the bumper. There are no tools required for this step, it pulls off by hand. (Fig C)

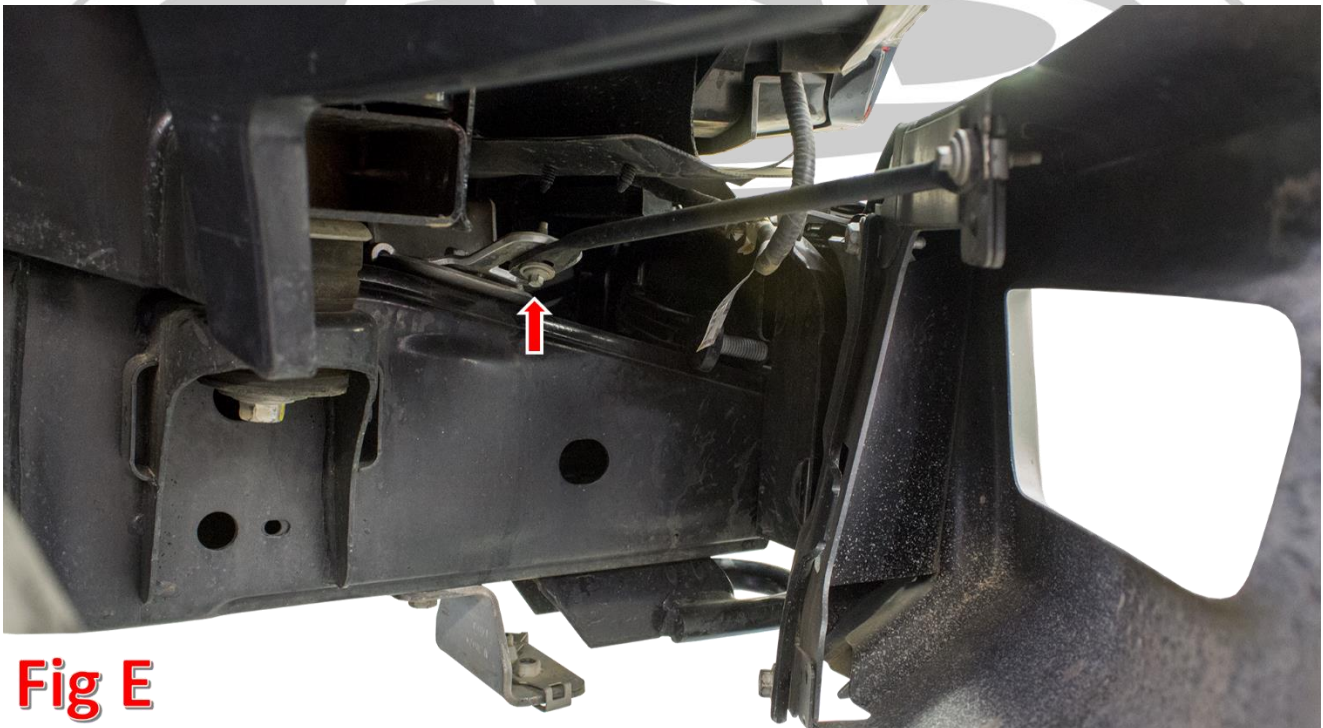


Fig C

4. Remove your Adaptive Cruise Control Module. (Fig D)
 - a. Using an 11mm Socket, remove the three nuts holding the Module on.
 - b. Using an E6 External Torx Socket, remove the three studs holding the Module on.
 - c. Remove the Module.



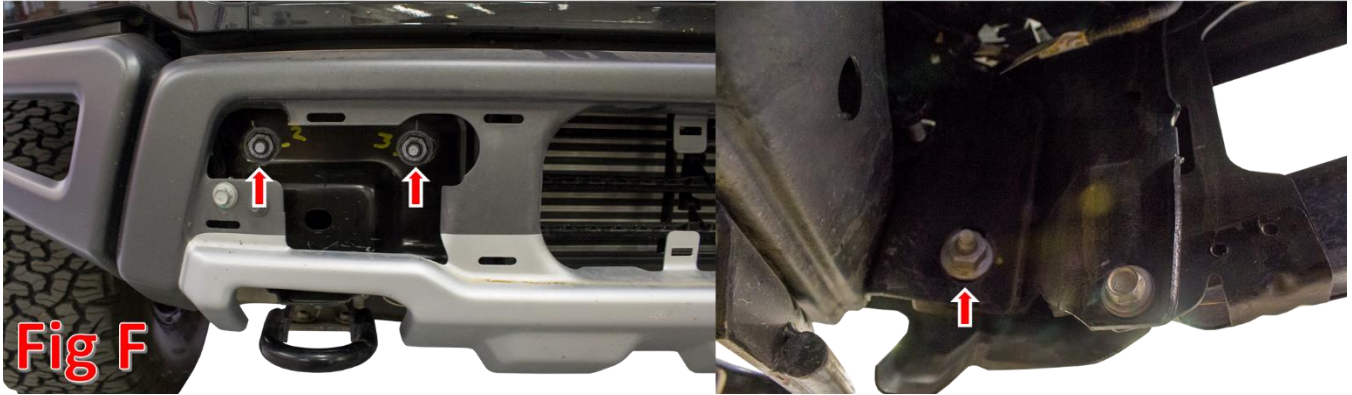
5. Remove the 8mm Bolt that holds on the bumper side support bar. Repeat this step on the other side. (Fig E)



6. Remove the 21mm Nuts that hold on the bumper. There are three per side. Two of the nuts (per side) face the front (they were hidden behind the plastic piece you removed in Removal Step 3). One of the nuts (per side) faces the rear of the vehicle and is accessible from underneath the truck. (Fig F)

View From the Front

View From the Rear



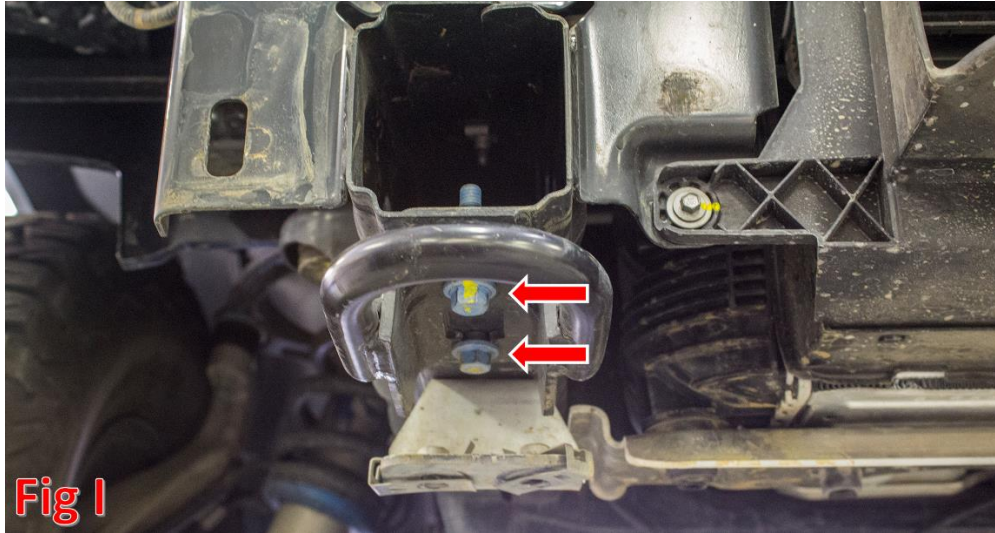
7. Remove the bumper from the truck. As you are removing the bumper, be sure to pull the rubber shroud from the plastic clips that attach it to the bumper. (Fig G)



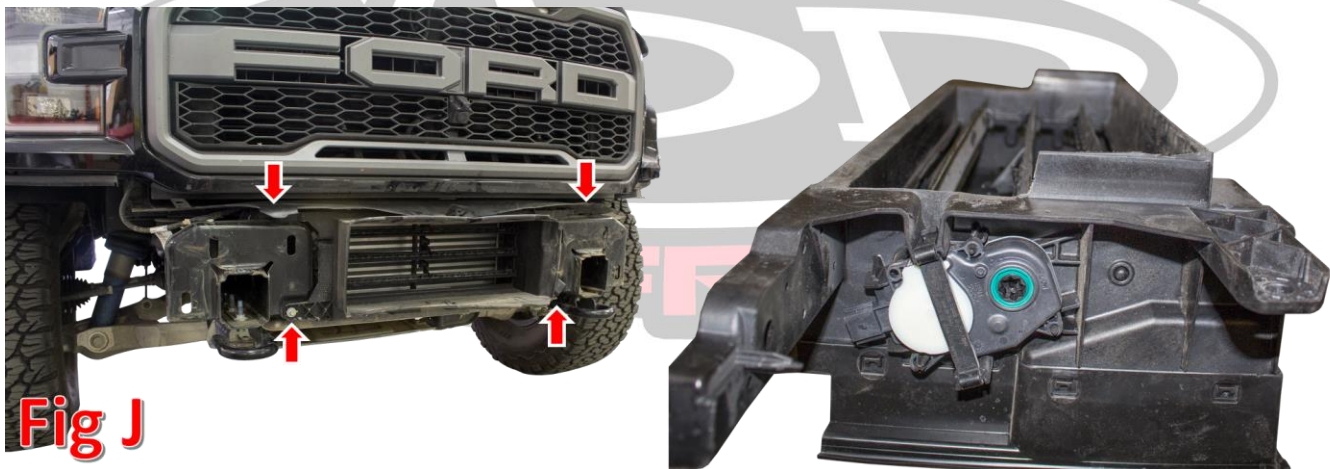
8. Remove each of the Skid Plate Brackets by removing the 13mm bolt that holds each of them on. There is one bolt per side. (Fig H)



9. Remove the tow hooks by removing the two 15mm bolts that hold each of them on. (Fig I)



10. Using a reciprocating saw or cutoff wheel, cut the intercooler scoop as shown in Fig J. The bottom half of the scoop gets trimmed to the point where the plastic and rubber meet, while the upper half of the scoop gets trimmed flush with the outer structure. You may do this on or off truck. If you would like to remove the scoop, remove the 8mm mounting bolts (x4). Reinstall the scoop when you're done cutting the scoop.



11. Prepare to install your new ADD Stealth Fighter Front Bumper.

INSTALLATION

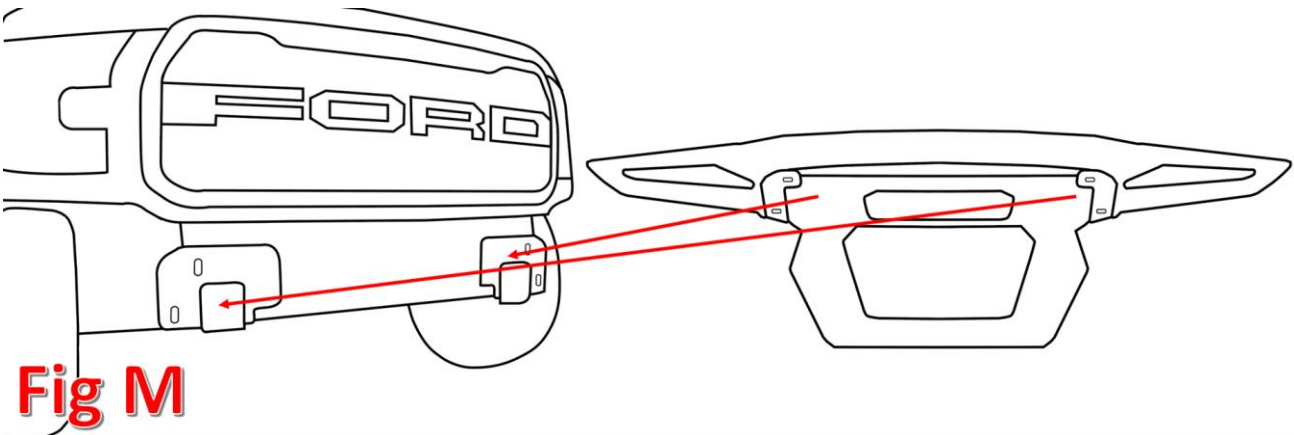
1. If you have any lights/winch to install on your bumper, now would be a good time to do so. For light/winch installation information, please follow the light manufacturer's instructions. If you are installing a winch on your bumper, now is also a good time to install your intercooler upgrade kit.
2. Install the supplied 3/8" U-Nuts (x2) into the holes in the cross member that lined up with the two rear skid plate bolt holes (You removed these bolts and the factory U-nuts in Removal Steps 1 & 2). (Fig K)



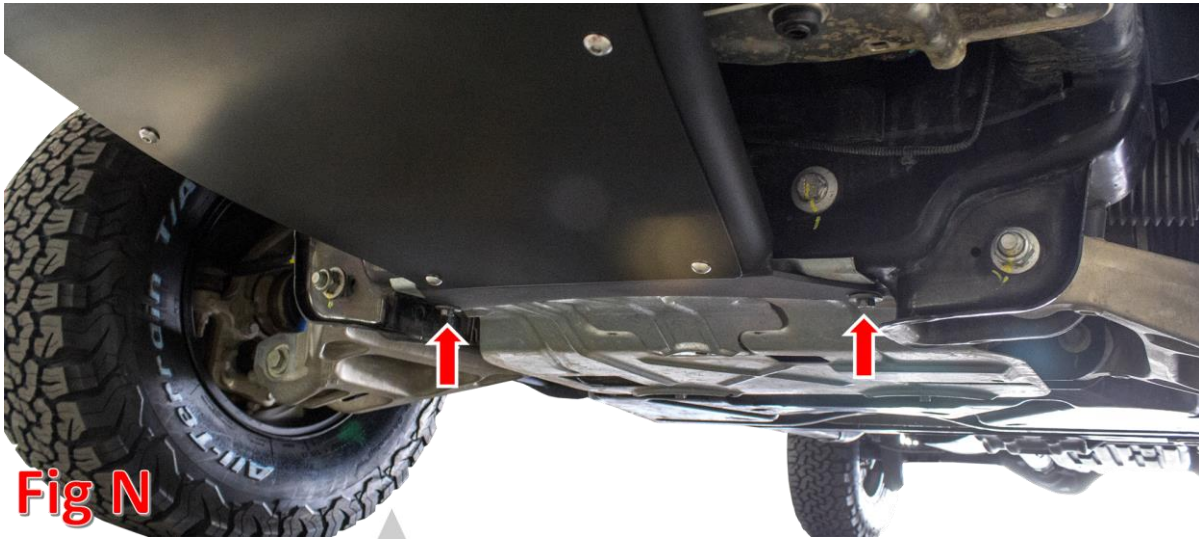
3. Install the supplied 1/2" U-Nuts on the upper bumper mounting holes. (Fig L)



4. Line the 4 mounting holes on the bumper up with the 4 mounting holes on your truck's frame horns. (Fig M) Hold the bumper to the truck by using the supplied 1/2" Bolts (x2), 1/2" Washers (x4), and 1/2" Lock Nuts (x2) on the bottom mounting holes. Then, from the back side of the frame horn, use the supplied 1/2" Bolts (x2) and 1/2" Washers (x2) on the upper mounting holes.



5. Line the bottom mounting holes on the skid plate portion of the front bumper up with the U-nuts you installed in Installation Step 2. Loosely install the supplied 3/8" Hex Head Bolts (x2) and 3/8" Washers (x2). (Fig N)



6. Align the bumper so that it is straight in relation to the grill/headlight bezels. You may need one person to hold the bumper in place while another person tightens the bolts.
7. Torque the supplied 1/2" bolts to 70 foot pounds. Torque the supplied 3/8" Hex Head Bolts to 20 foot pounds.
8. Stand back and enjoy your new ADD Stealth Fighter Front Bumper.
9. Check and re-tighten if needed, all mounting bolts after 100 miles and periodically thereafter.



**For Additional Support or Technical Questions,
Please Call 480.671.0820 or
Email info@addictivedesertdesigns.com**