

WeatherTech®

Easy-On™ Stone & Bug Deflectors

Important Safety Information



- CAUTION - Before driving, ensure that the hood shield is properly anchored to vehicle.
- Do not use automatic "brush-style" car washes.
- Do not use cleaning solvents of any kind.
- Periodically check all components for tightness.

Contents **NOTE:** Actual product may vary from illustration.

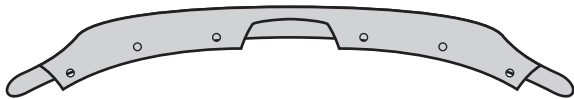

Hood Shield

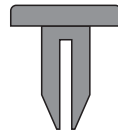

2-Piece Fastener Receptacle x6

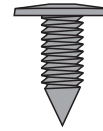

2-Piece Fastener Screw x6

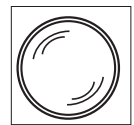

Bump On x4

Tools Required



Car Wash Supplies

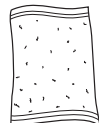

Clean Towel

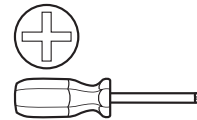

Phillips Screwdriver

Preparation Before Painting / Installation

- A trial fit is recommended to ensure proper positioning and fit.
- Check fit of parts before painting as we will not accept the return of modified or painted parts.
- Wash your vehicle's hood to remove any debris and/or dirt.
- Dry the hood with a clean towel.

Installation Steps **NOTE:** Actual application may vary slightly from illustrations.

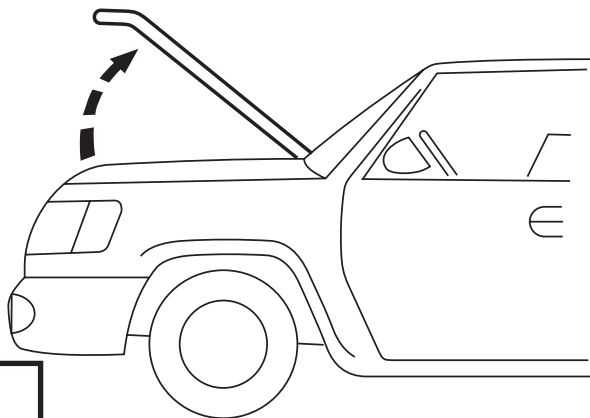

1

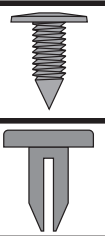

2

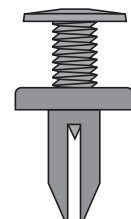
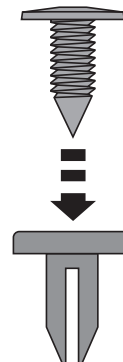

X6

Installation Steps

NOTE: Actual application may vary slightly from drawings.

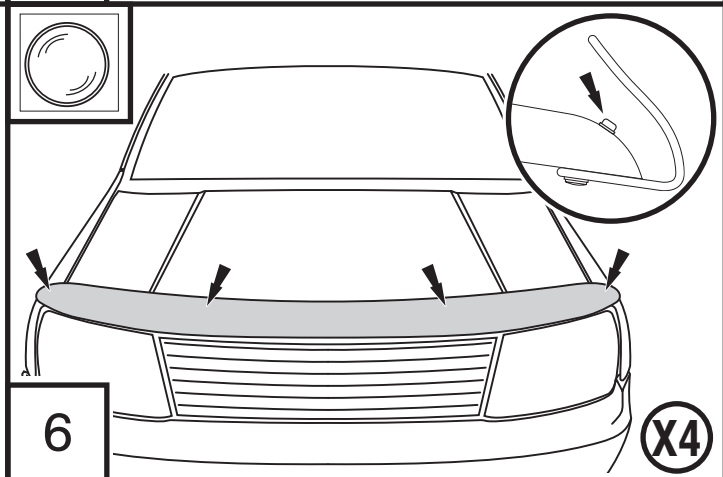
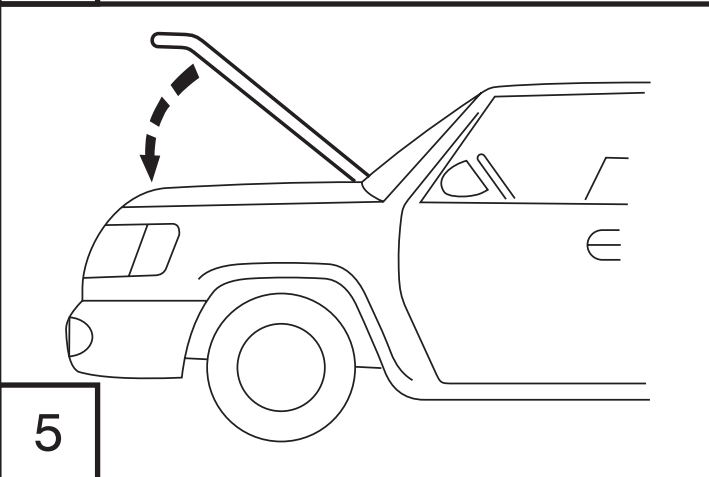
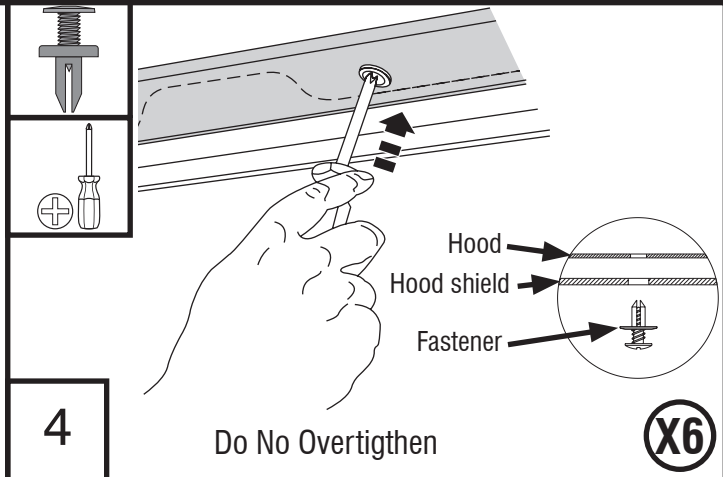
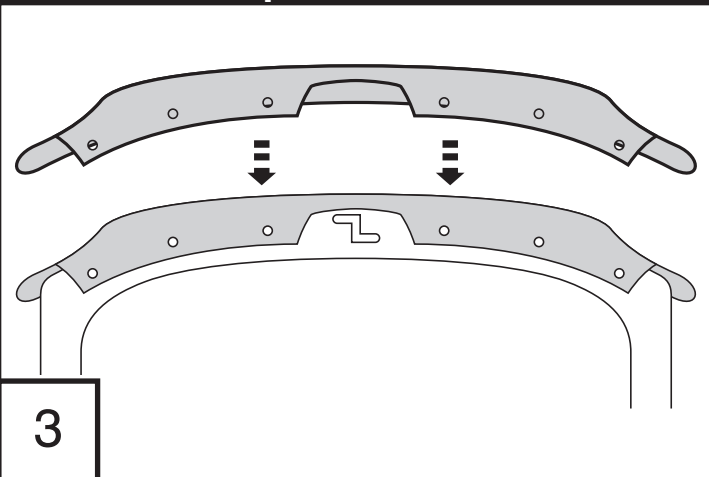

Care and Cleaning

- Wash only with mild soap & dry with a clean cloth.



1 MacNeil Ct.
Bolingbrook, IL 60515
Questions? Call customer service @ 630.769.1500
Monday - Friday, 9 a.m. to 5 p.m. Central Time
www.WeatherTech.com

WeatherTech®

Easy-On™ Stone & Bug Deflectors

Informations importantes concernant la sécurité



- ATTENTION – Avant de conduire, s'assurer que le pare-insectes est solidement assujéti sur le véhicule.
- Ne pas utiliser les stations de lavage de voitures à brosses.
- Ne pas utiliser de solvants.
- Vérifier régulièrement le serrage des composants.

Contenu **NOTE:** Le produit réel peut changer de l'illustration.

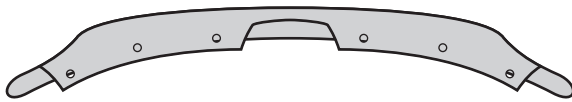

Pare-insectes

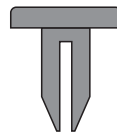

Réceptacles de fixation 2 pièces (6)

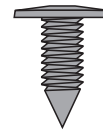

Vis de fixation 2 pièces (6)

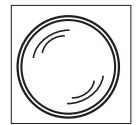

Butoirs (4)

Outils nécessaires



Fournitures pour lavage de voiture



Serviette propre

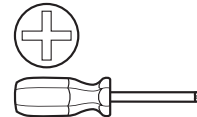

Tournevis Phillips

Préparation pour la peinture/l'installation

- Il est recommandé de procéder à un essai pour s'assurer que le positionnement et l'ajustement sont corrects.
- Vérifier l'ajustement des pièces avant peinture, car nous n'acceptons pas le retour de pièces modifiées ou peintes.
- Laver le capot du véhicule pour éliminer toute poussière et tous débris.
- Sécher le capot avec une serviette propre.

Étapes d'installation

REMARQUE : La méthode d'application peut être légèrement différente de celle représentée par les illustrations.

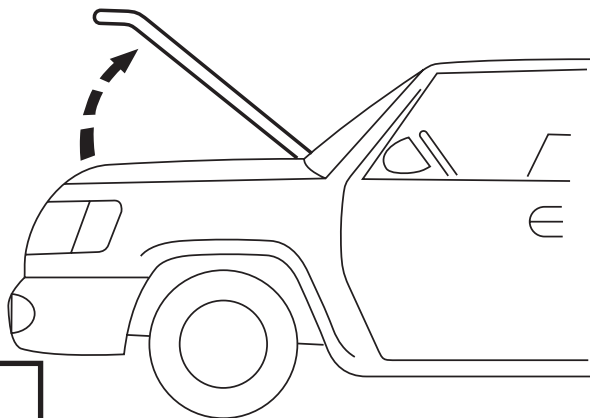

1

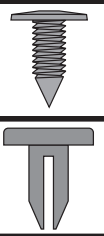

2

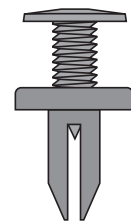
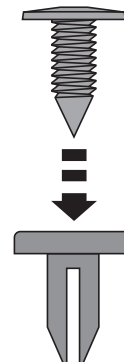

(X6)

Étapes d'installation

REMARQUE : La méthode d'application peut être légèrement différente de celle représentée par les illustrations.

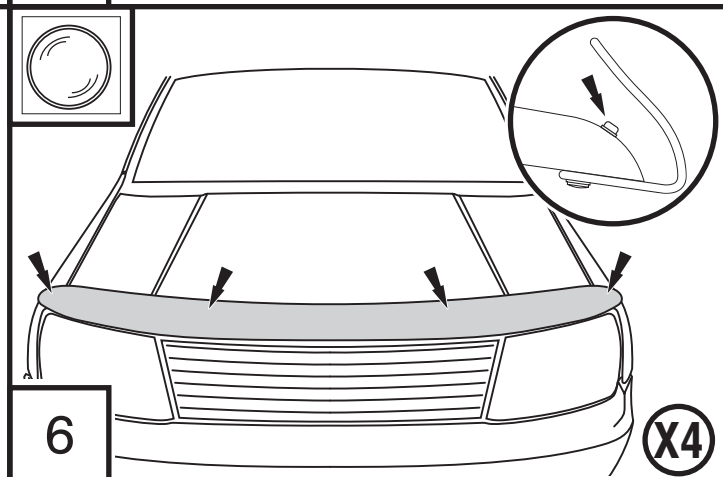
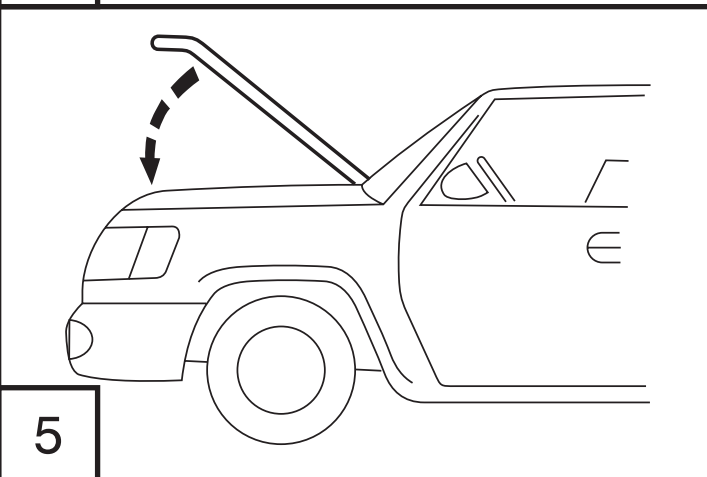
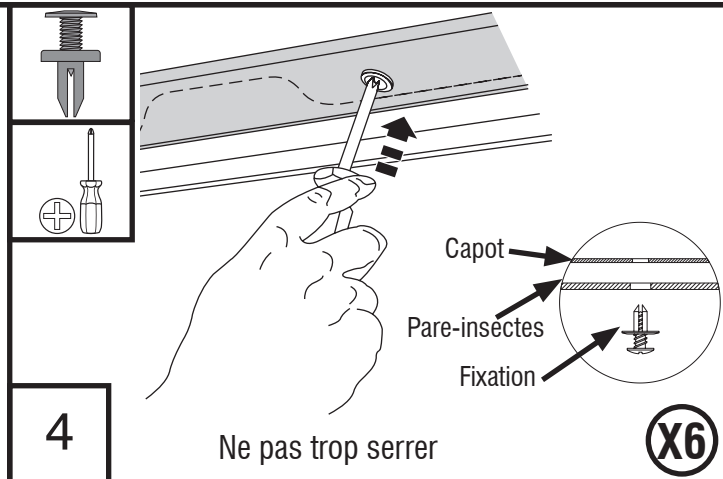
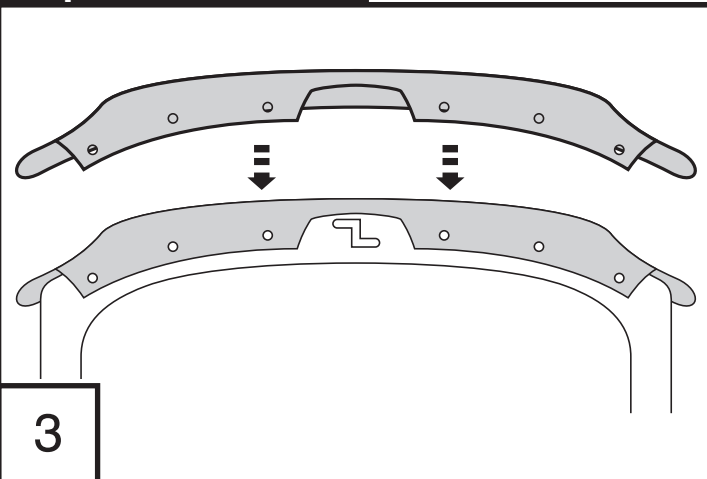

Entretien et nettoyage

- Laver exclusivement avec de l'eau savonneuse et sécher avec un chiffon propre.



1 MacNeil Ct.

Bolingbrook, IL 60515

Questions? Call customer service @ 630.769.1500

Monday - Friday, 9 a.m. to 5 p.m. Central Time

www.WeatherTech.com

WeatherTech®

Easy-On™ Stone & Bug Deflectors

Información importante de seguridad



- PRECAUCIÓN - Antes de conducir, asegúrese de que la cubierta para capó esté correctamente anclada al vehículo.
- No utilice servicios automáticos de limpieza de vehículos que utilizan cepillos.
- No utilice limpiadores al solvente de ningún tipo.
- Compruebe periódicamente que todos los componentes estén ajustados.

Contenido **NOTA:** El producto real puede variar de la ilustración.

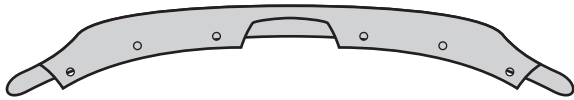

Cubierta para capó

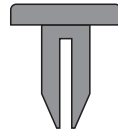

Receptáculo
sujetador de dos
piezas x 6

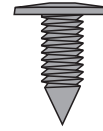

Tornillo sujetador
de dos piezas x 6

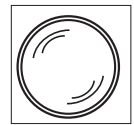

Soporte x 4

Herramientas necesarias



Equipo de limpieza de vehículos



Toalla limpia

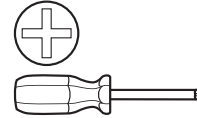

Destornillador Phillips

Preparación antes de pintar o instalar

- Se recomienda realizar un ajuste de prueba para asegurar el posicionamiento y ajuste correctos.
- Compruebe que las piezas se ajusten correctamente antes de pintarlas, ya que no aceptaremos la devolución de piezas modificadas o pintadas.
- Lave el capó del vehículo para quitar los desechos y la suciedad.
- Seque el capó con una toalla limpia.

Pasos de instalación **NOTA:** El uso real puede variar levemente de ilustraciones.

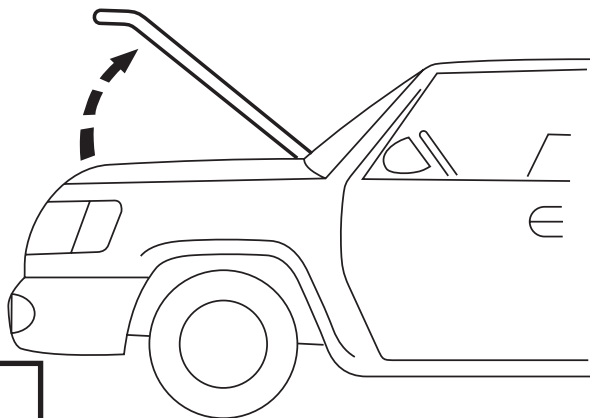

1

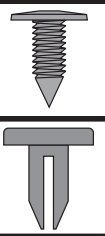

2

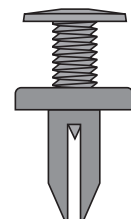
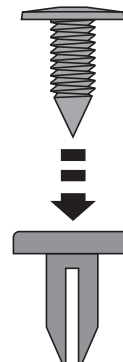

X6

Pasos de instalación

AVISO: La colocación real puede variar levemente con respecto a las ilustraciones.

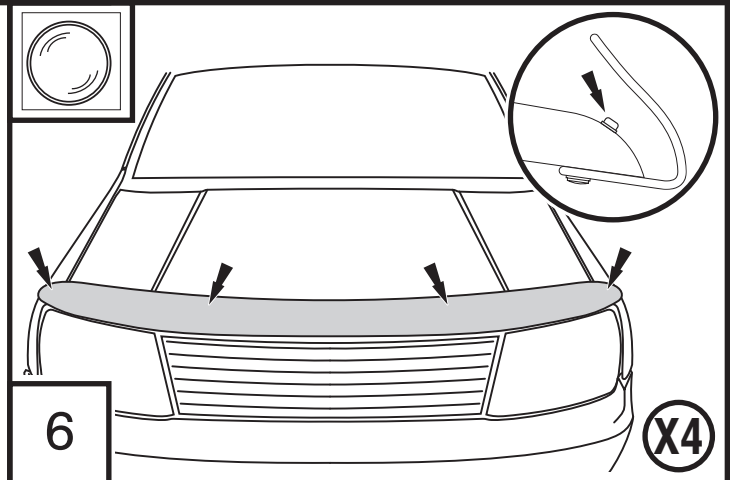
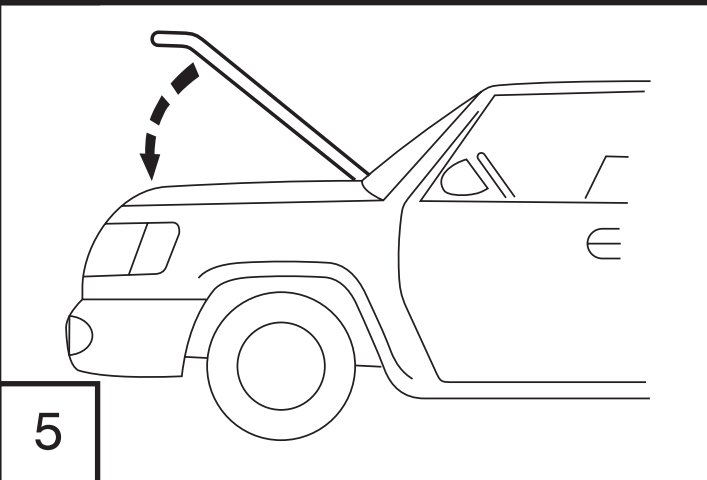
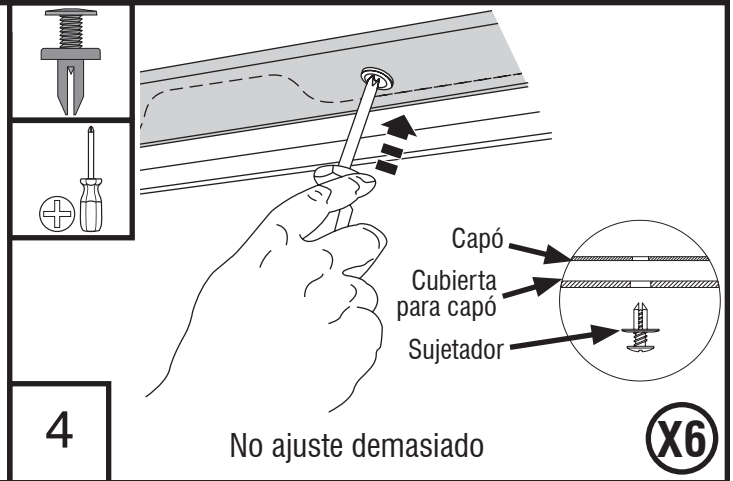
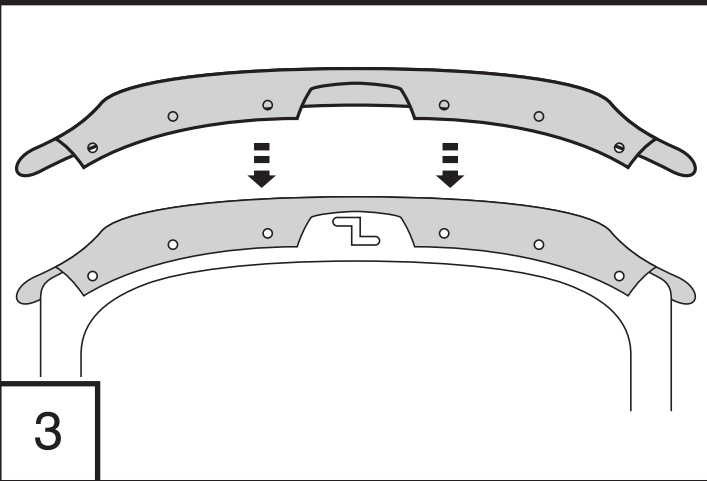

Cuidado y limpieza

- Limpie solamente con agua jabonosa tibia y seque con un paño limpio.



1 MacNeil Ct.
Bolingbrook, IL 60515
Questions? Call customer service @ 630.769.1500
Monday - Friday, 9 a.m. to 5 p.m. Central Time
www.WeatherTech.com