

BLACK MODULAR GRILL GUARD FOR 04-08 F150/04-08 F150 SUPER CREW(EXCLUDES HERITAGE)



INSTALLATION INSTRUCTIONS

**BLACK MODULAR GRILL GUARD FOR 04-08 F150/04-08 F150 SUPER
CREW(EXCLUDES HERITAGE)
PART # 17FP28MA**



Before Installation

- Please read the instruction completely for e
- Easy installation, which will also help you to avoid scratches or other potential damages to your appealing car.
- The information shown here is for reference only and may different from the product that you receive, however the goods are fitted in the same way.



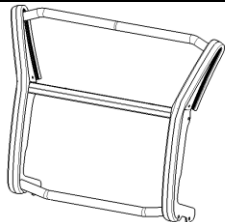
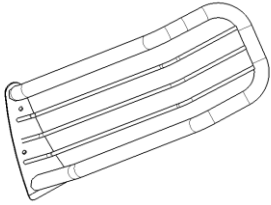
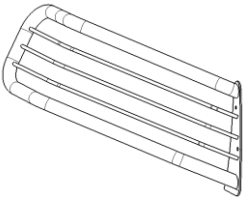

Care and Cleaning

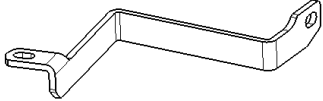
- Mild soap may be used also to clean the product.
- Please periodically check and retighten all the hardware and clean the investment for a refresh look.

Parts list

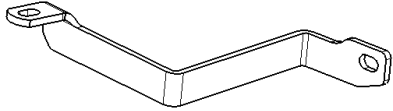
NO.	QTY	NAME	NO.	QTY	NAME
①	1	 Grille Guard	②	1	 Brush Guard(L)
③	1	 Brush Guard(R)	④	1	 Driver Left Top Support Bracket For 04-05
⑤	1	 Passenger Top Support Bracket For 04-05	⑥	1	 Driver Left Top Support Bracket For 06-08

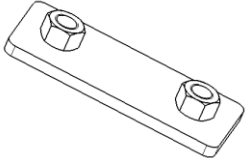
BLACK MODULAR GRILL GUARD FOR 04-08 F150/04-08 F150 SUPER CREW(EXCLUDES HERITAGE)

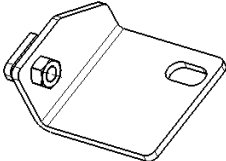
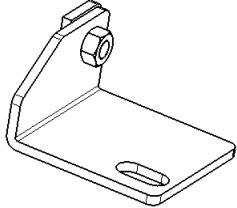
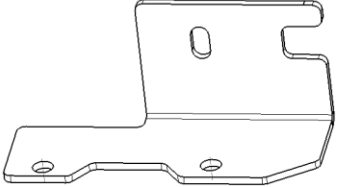
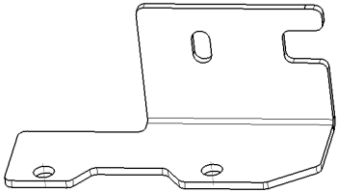
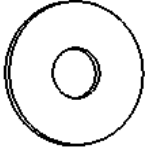
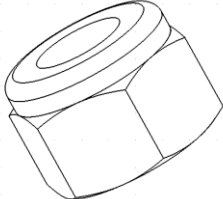
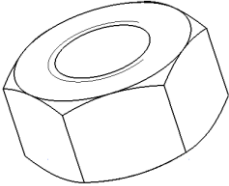
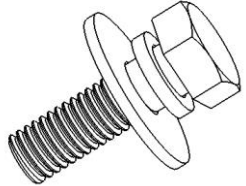
<p>⑦</p> <p>1</p>	 <p>Passenger Right Top Support Bracket For 06-08</p>	<p>⑧</p> <p>1</p>	 <p>Wrench Allen wrench S=5</p>
<p>⑨</p> <p>2</p>	 <p>12mm Double Nut Plate</p>	<p>⑩</p> <p>2</p>	 <p>10mm Lock Split Washer</p>
<p>⑪</p> <p>1</p>	 <p>Driver/ Top Mounting Bracket For 06-08</p>	<p>⑫</p> <p>1</p>	 <p>Passenger/Right Top Mounting Bracket For 06-08</p>
<p>⑬</p> <p>1</p>	 <p>Driver/Left Frame Mounting Bracket</p>	<p>⑭</p> <p>1</p>	 <p>Passenger/Right Frame Mounting Bracket</p>
<p>⑮</p> <p>2</p>	 <p>8mm x 24mm OD x 2mm Large Flat Washer (Q235A)</p>	<p>⑯</p> <p>6</p>	 <p>12mm Nylon Lock Nut</p>
<p>⑰</p> <p>2</p>	 <p>8mm Hex Nut</p>	<p>⑱</p> <p>2</p>	 <p>8mmx25mm Hex Bolt & Lock Split washer & Flat Washer Assembly</p>

BLACK MODULAR GRILL GUARD FOR 04-08 F150/04-08 F150 SUPER CREW(EXCLUDES HERITAGE)

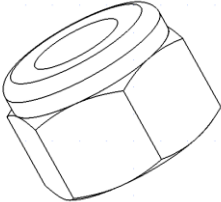
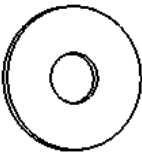
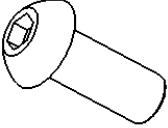
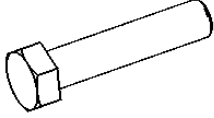
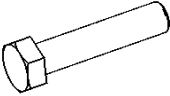
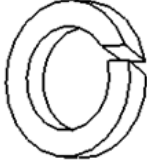
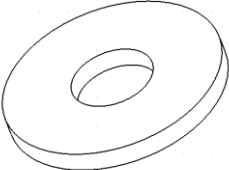
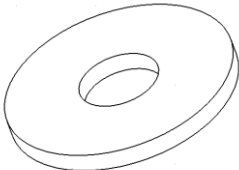
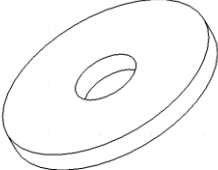
<p>①9</p>	<p>6</p>	 <p>8mm Nylon Lock Nut</p>	<p>②0</p>	<p>12</p>	 <p>8mm x 24mm OD x 2mm Large Flat Washer (SUS304)</p>
<p>②1</p>	<p>6</p>	 <p>8mm x 25mm Button Head Bolt</p>	<p>②2</p>	<p>10</p>	 <p>12mm x 40mm Hex Bolt</p>
<p>②3</p>	<p>2</p>	 <p>10mm x 40mm Hex Bolt</p>	<p>②4</p>	<p>4</p>	 <p>12mm Lock Split Washer</p>
<p>②5</p>	<p>12</p>	 <p>12mm x 32 mm OD x 3mm Flat Washer</p>	<p>②6</p>	<p>2</p>	 <p>10mm x 30mm OD x 2.5mm Large Flat Washer</p>
<p>②7</p>	<p>4</p>	 <p>12mm x 44 mm OD x 4mm Large Flat Washer</p>			

Installation Step

Install left and right brush guard on the grille guard as figure 1.

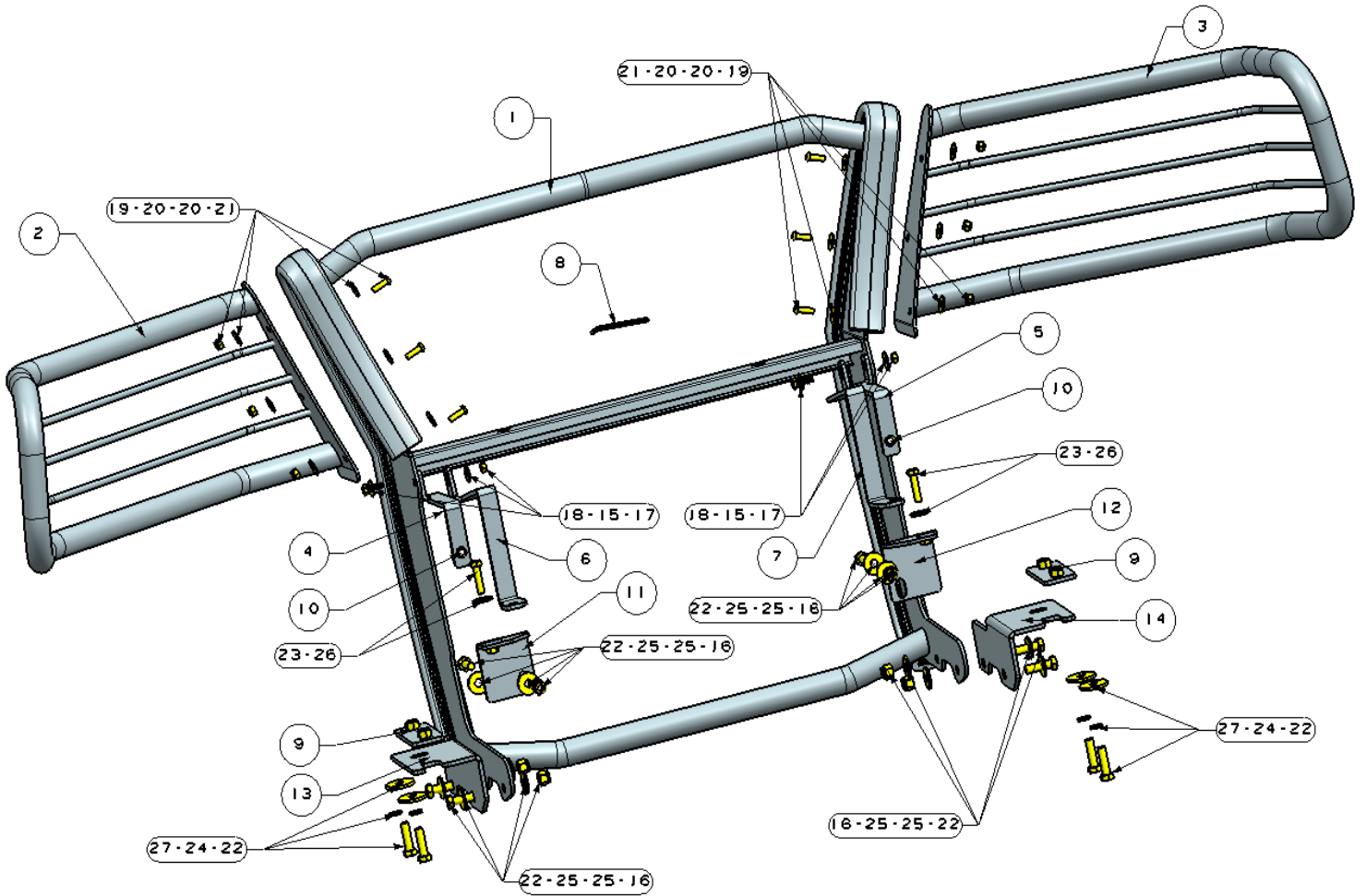

BLACK MODULAR GRILL GUARD FOR 04-08 F150/04-08 F150 SUPER CREW(EXCLUDES HERITAGE)

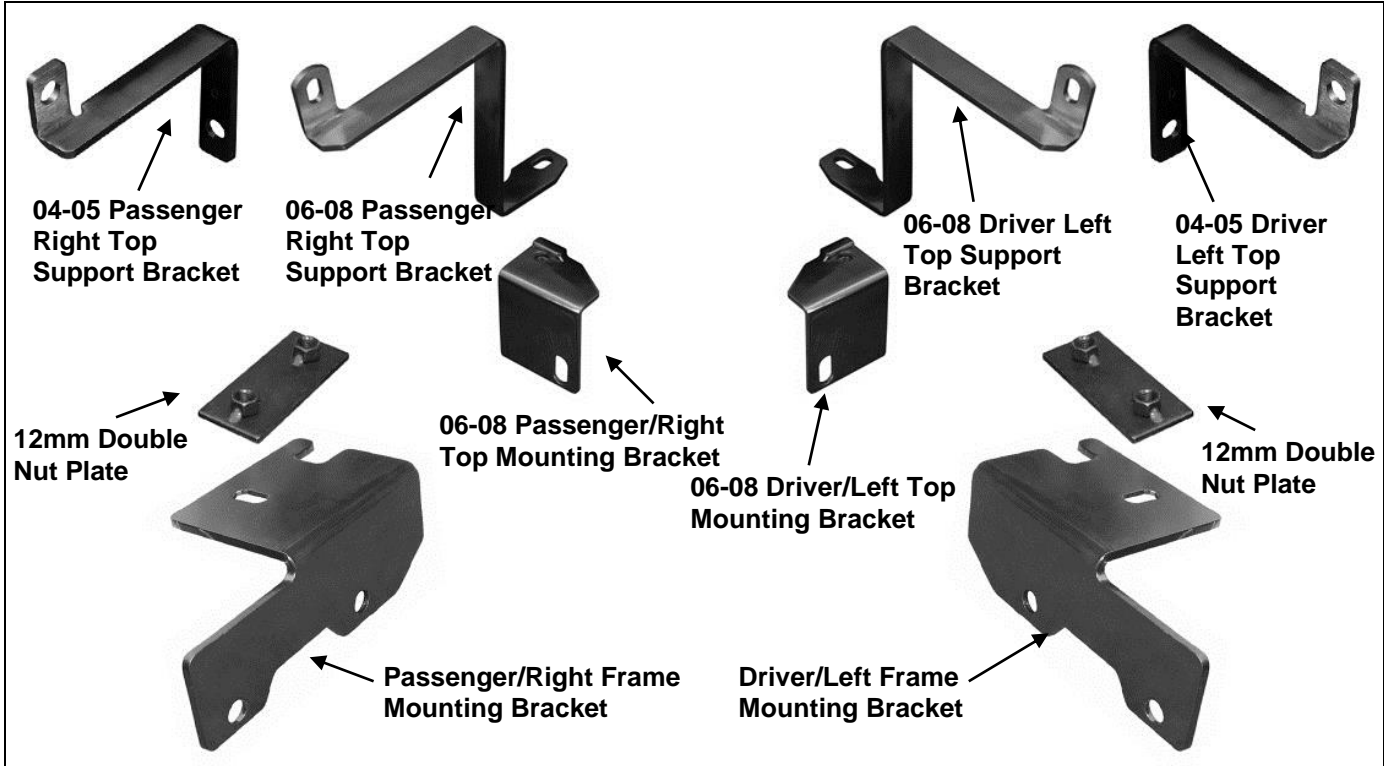

PROCEDURE:

REMOVE CONTENTS FROM BOX. VERIFY ALL PARTS ARE PRESENT. READ INSTRUCTIONS CAREFULLY BEFORE STARTING INSTALLATION. CUTTING MAY BE REQUIRED.

1. Determine if the vehicle is equipped with or without factory tow hooks.

Vehicles with factory tow hooks:

- a. Start on the driver side and remove the forward hex bolt in the tow hook. Next, loosen the rear bolt but do not remove, (this will help hold the nut plate in the correct location inside the frame channel-see **Figure 2**). Slide the tow hook out from under the rear hex bolt. Keep the factory double nut plate in the frame and aligned with the holes.

- b. Position the Mounting Bracket up to the bottom of the frame and secure it with the factory tow hook bolts into the factory double nut plate, (**Figure 3**).

NOTE: On some model years, the Grille Guard Brackets may not be compatible with the factory tow hooks. Reinstall the tow hook over the Bracket with the factory hex bolts if there is clearance.

- c. Repeat **Steps a – b** for the passenger side Frame Bracket installation.

Vehicles without Tow Hooks:

- a. Remove the lower plastic bumper cover/air dam, (**Figure 4**).

- b. Starting on the driver side of the vehicle, insert (1) ⑨ 12mm Double Nut Plate through the opening in the open front end of the frame, (**Figures 5A & 5B**). Line up the threaded hex nuts on the Nut Plate with the (2) factory holes in the bottom of the frame channel. Hold the Nut Plate in position with (1) ⑫ 12mm x 40mm Hex Bolt, (1) ⑭ 12mm Lock Split Washer and (1) ⑰ 12mm x 44mm Large Flat Washer partially threaded into the rearmost threaded hole in the Nut Plate, (**Figure 6**).

- c. Select the driver side Frame Mounting Bracket. Slide the slot in the Bracket under the 12mm Hex Bolt and Washers. Line up the remaining hole in the Bracket with the forward hole in the Nut Plate. Insert (1) ⑫ 12mm x 40mm Hex Bolt, (1) ⑭ 12mm Lock Split Washer and (1) ⑰ 12mm x 44mm Large Flat Washer into the remaining hole in the Bracket, (**Figure 6**). Snug but do not fully tighten hardware at this time.

BLACK MODULAR GRILL GUARD FOR 04-08 F150/04-08 F150 SUPER CREW(EXCLUDES HERITAGE)

- d. Repeat **Steps b – c** to install the passenger side Frame Bracket.
 - e. Hold the bumper cover up to the vehicle and mark the location of the (2) Brackets onto the inside of the cover, (**Figures 7 & 8**). Carefully cut (2) slots through the cover wide enough to clear the (2) Brackets, (**Figure 9**). **IMPORTANT:** Do not cut through the top or bottom edge of the cover. Reinstall the cover with the factory hardware.
2. With help position the Grille Guard onto the inside of the Mounting Brackets. Use the included (4) ② 12mm x 30mm Hex Bolts, (8) ⑦ 12mm x 44mm Large Flat Washer and (4) 12mm Nylon Lock Nuts to attach the Grille Guard to the Mounting Brackets, (**Figure 3**). Do not tighten at this time.
 3. Slowly open the hood and check for clearance. Select the appropriate Top Bracket installation:
 - 04 – 05 model years:**
 - a. Locate and remove the factory nut on the top of the bumper bracket. Select the driver side 04-05 Top Bracket, (**Figure 10**).
 - b. Apply a section of the included Adhesive Backed Foam Tape to the Bracket in any location that may come in contact with the bumper or grille, (**Figure 10**).
 - c. Attach the Bracket to the bumper bolt with the factory hex nut, (**Figure 11**). Leave hardware loose at this time. Repeat **Steps a – b** for passenger side Support Bracket installation.
 - 06 – 08 model years:**
 - a. Locate the back of the factory bumper bracket, (**Figure 12**). Select the small driver side 06-08 Top Mounting Bracket, (**Figure 13**). Bolt the Bracket to the back of the large factory hole in the bumper bracket with (1) ② 12mm x 40mm Hex Bolt, (2) ⑤ 12mm x 32 mm OD x 3mm Flat Washer and (1) ① 12mm Nylon Lock Nut, (**Figures 14A & 14B**).
 - b. Select the driver side 06-08 Top Support Bracket, (**Figure 15**). Apply a section of the included Adhesive Backed Foam Tape to the Bracket in any location that may come in contact with the bumper or grille, (**Figure 16**).
 - c. Bolt the Support Bracket to the top of the Mounting Bracket with (1) ③ 10mm x 40mm Hex Bolt, (1) ⑥ 10mm x 30mm OD x 2.5mm Large Flat Washer, (**Figure 16**).
 - d. Tighten the Top Mounting Bracket to the bumper bracket hardware but leave the Top Support Bracket loose at this time. Repeat **Steps a – c** for passenger side installation.
 4. Line up the tab on the driver side Top Bracket with the hole in the upright on the Grille Guard. Insert (1) ⑧ 8mmx25mm Hex Bolt & Lock Split washer & Flat Washer Assembly through the upright and Top Bracket. Secure the Bracket to the Grille Guard with (1) ⑤ 8mm x 24mm OD x 2mm Large Flat Washer and (1) ⑦ 8mm Nylon Lock Nut, (**Figures 11 & 17**). Leave hardware loose at this time.
 5. Repeat **Step 4** for passenger side Top Support Bracket to Grille Guard installation.
 6. Align and adjust the Grille Guard properly and tighten all hardware.
 7. Do periodic inspections to the installation to make sure that all hardware is secure and tight.

To protect your investment, wax this product after installing. Regular waxing is recommended to add a protective layer over the finish. Do not use any type of polish or wax that may contain abrasives that could damage the finish.

For stainless steel: Aluminum polish may be used to polish small scratches and scuffs on the finish. Mild soap may be used also to clean the Grille Guard.

For gloss black finishes: Mild soap may be used to clean the Grille Guard.

BLACK MODULAR GRILL GUARD FOR 04-08 F150/04-08 F150 SUPER CREW(EXCLUDES HERITAGE)
Driver Side Installation Pictured

Remove tow hooks if equipped

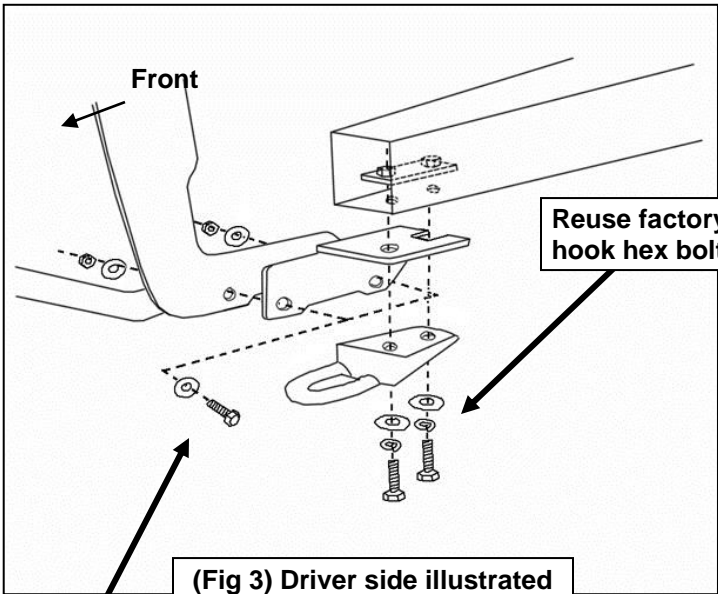
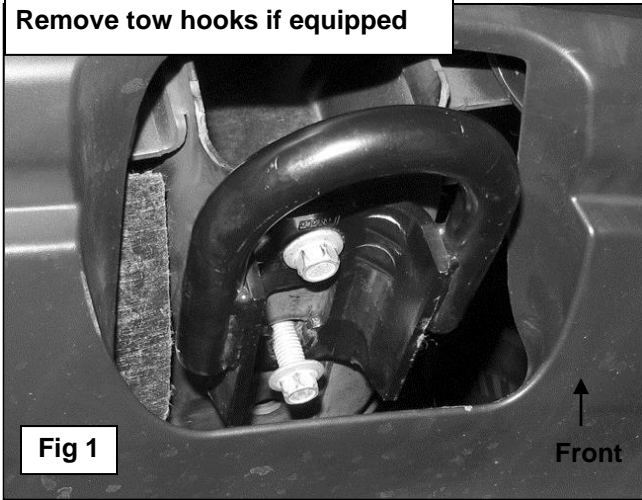

- (2) 12mm x 40mm Hex Bolt
- (4) 12mm 32mm OD x 3mm Flat Washers
- (2) 12mm Nylon Lock Nuts

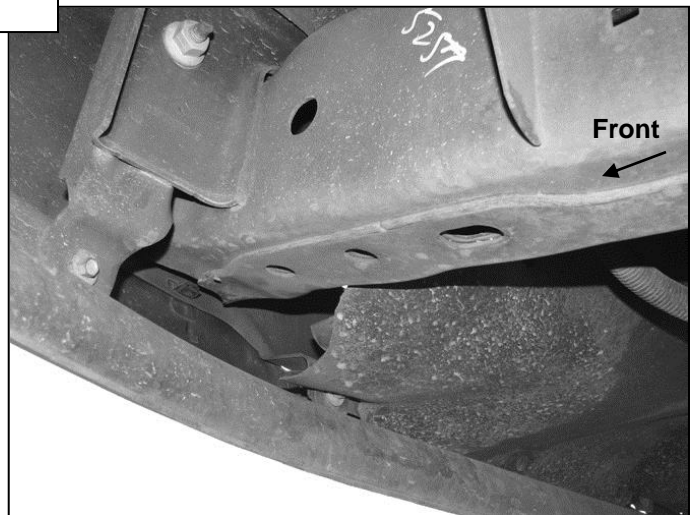

Driver Side Installation Pictured

Insert Nut Plate through opening in end of frame

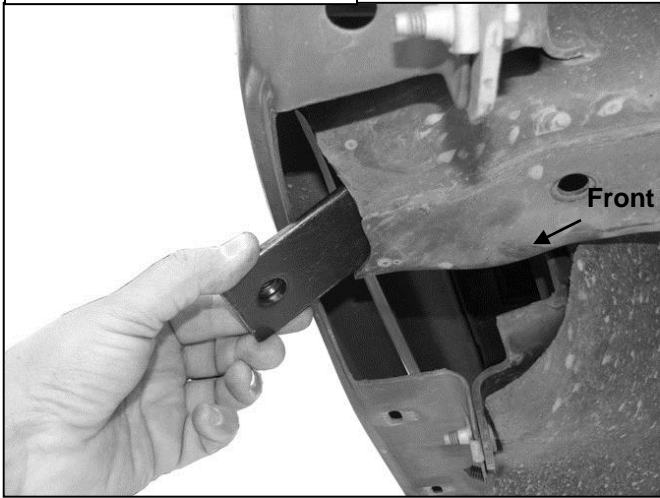

(Fig 5A) Remove plastic lower bumper air dam

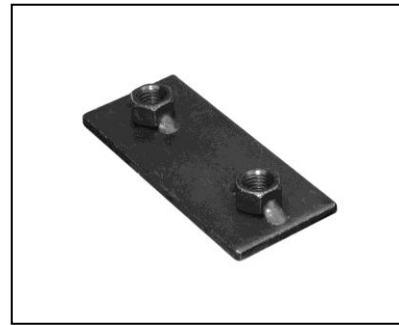

(Fig 5B) Double Nut Plate

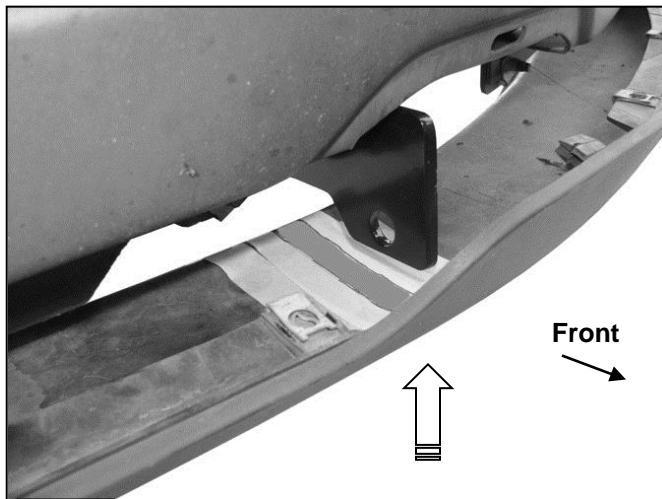

Fig 7

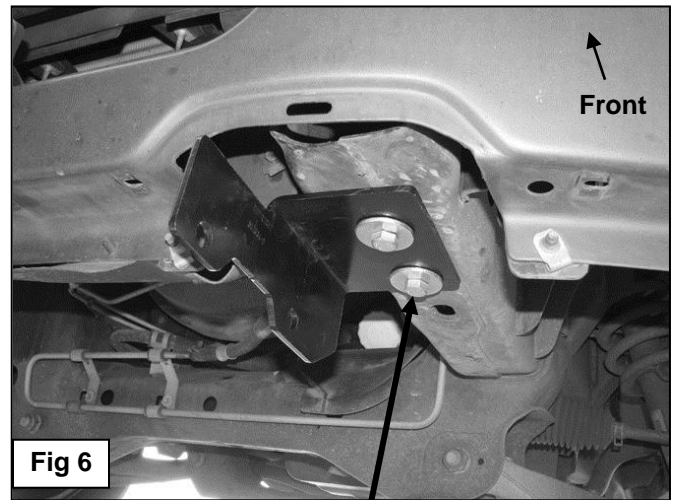

Fig 6

- (2) 12mm x 40mm Hex Bolt
- (2) 12mm Lock Split Washer
- (2) 12mm 44mm OD x 4mm Large Flat Washer

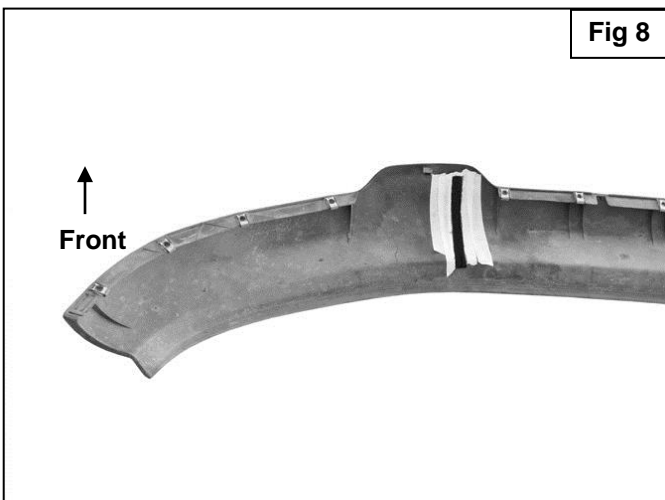
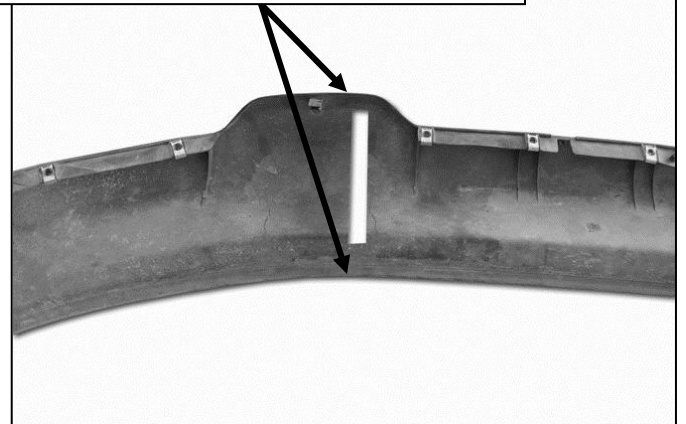

Fig 8

Important: Do not cut through the front or rear edge of the plastic bumper cover

Fig 9



Driver Side Installation Pictured

Apply Foam Tape to top and/or bottom of Support Bracket as necessary

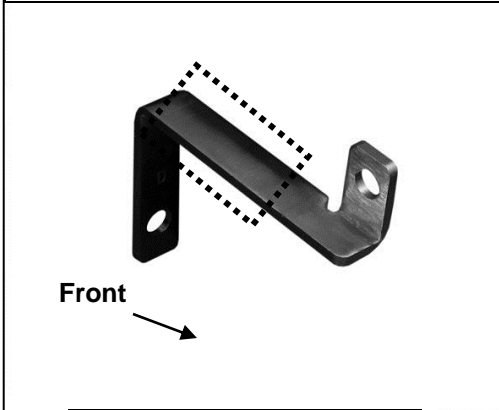

(Fig 10) 04-05 Driver side Top Support Bracket

8mmx25mm Hex Bolt & Lock Split washer & Flat Washer Assembly
8mm x 24mm OD x 2mm Large Flat Washer
8mm Hex Nut

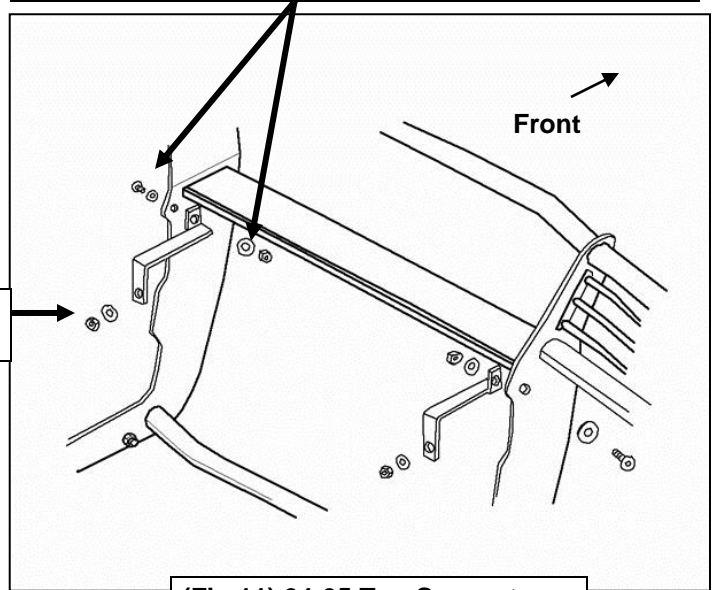

(Fig 11) 04-05 Top Support Bracket installation illustrated

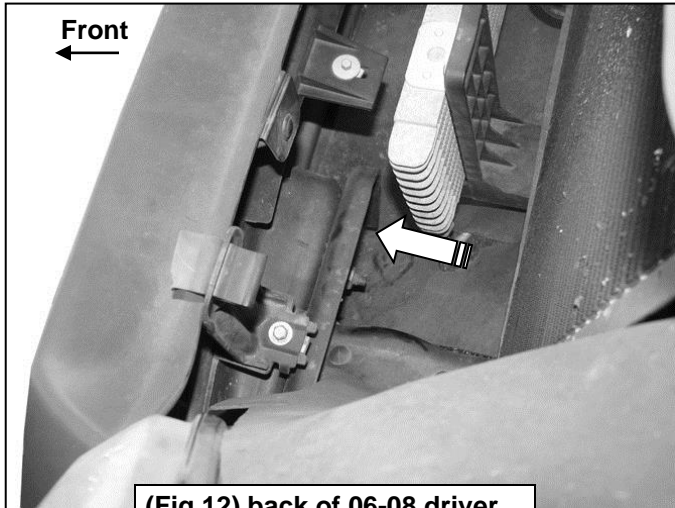

(Fig 12) back of 06-08 driver side bumper bracket pictured

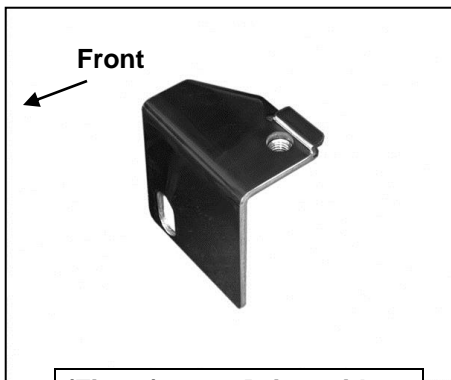

(Fig 13) 06-08 Driver side Top Mounting Bracket

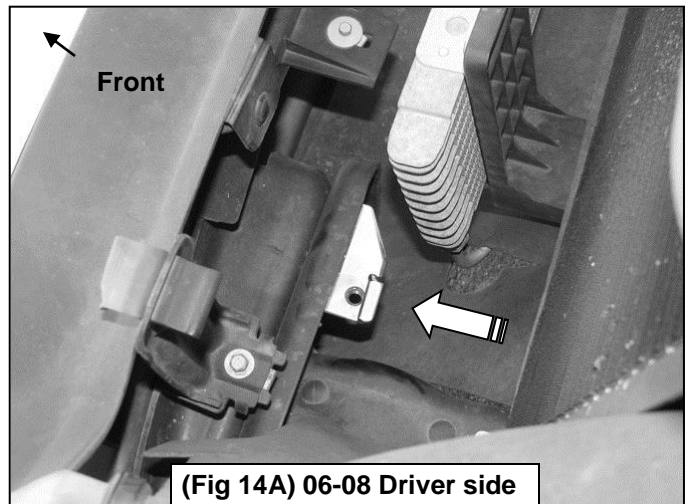

(Fig 14A) 06-08 Driver side Top Mounting Bracket

**BLACK MODULAR GRILL GUARD FOR 04-08 F150/04-08 F150 SUPER CREW(EXCLUDES HERITAGE)
Driver Side Installation Pictured**

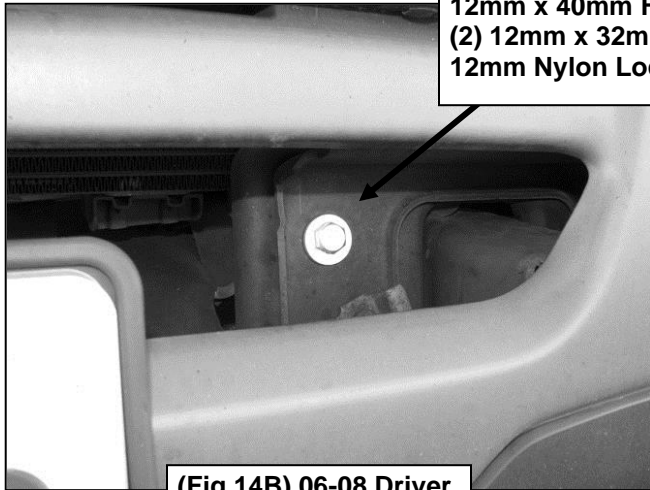

**12mm x 40mm Hex Bolt
(2) 12mm x 32mm Flat Washer
12mm Nylon Lock Nut**

(Fig 14B) 06-08 Driver side bumper bracket

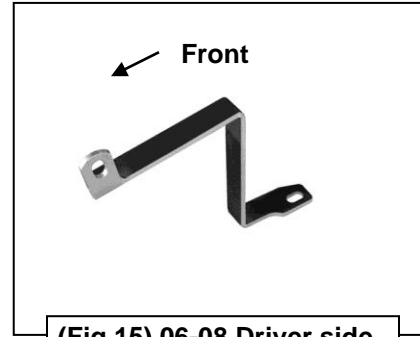

(Fig 15) 06-08 Driver side Top Support Bracket

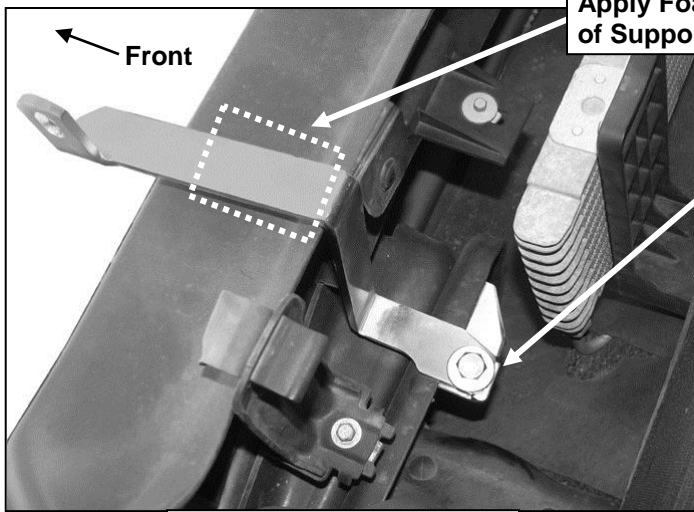

Apply Foam Tape to top and/or bottom of Support Bracket as necessary

**10mm x 40mm Hex Bolt
10mm x 30mm OD x 2.5mm Large Flat Washer**

(Fig 16) 06-08 Driver side Top Support Bracket

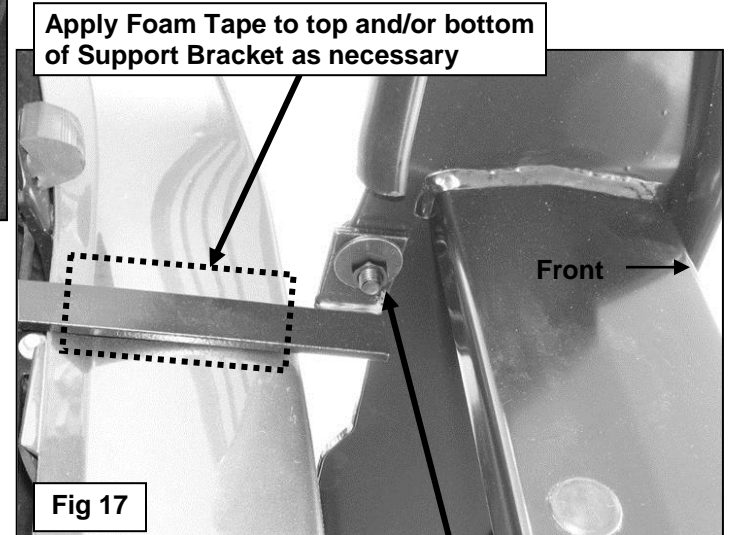

Apply Foam Tape to top and/or bottom of Support Bracket as necessary

Fig 17

**8mmx25mm Hex Bolt & Lock Split washer & Flat Washer Assembly
8mm x 24mm OD x 2mm Large Flat Washer
8mm Hex Nut**



Complete Installation